

SHARP

DVD PLAYER

MODEL

DV-SL1200W DV-SL2200W

OPERATION MANUAL



Thank you for purchasing this SHARP product. To obtain the best performance from this product, please read this manual carefully. It will guide you in operating your SHARP product.

(DV-SL1200W)

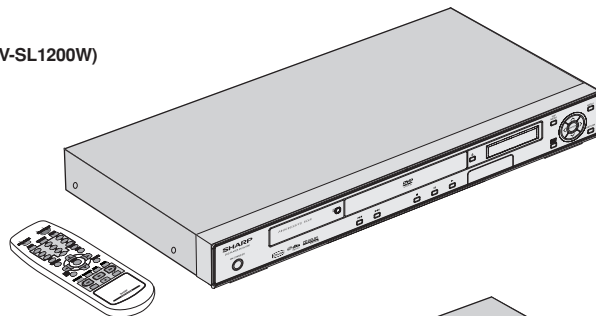

(DV-SL2200W)

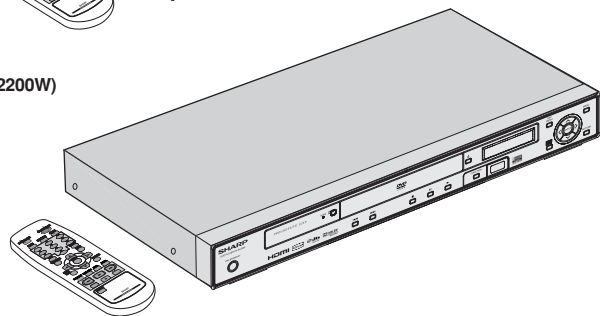

SHARP CORPORATION

Special notes

WARNINGS:

- When the ON/STAND-BY button is set at STAND-BY position, mains voltage is still present inside the unit. When the ON/STAND-BY button is set at STAND-BY position, the unit may be brought into operation by remote control.
- This unit contains no user serviceable parts. Never remove covers unless qualified to do so. This unit contains dangerous voltages, always remove mains plug from the wall socket before any service operation and when not in use for a long period.
- To prevent fire or shock hazard, do not expose this appliance to dripping or splashing. No objects filled with liquids, such as vases, shall be placed on the apparatus.

CAUTION:

- This product is classified as a CLASS 1 LASER product.
- Use of controls, adjustments or performance of procedures other than those specified herein may result in hazardous radiation exposure. As the laser beam used in this compact disc player is harmful to the eyes, do not attempt to disassemble the cabinet. Refer servicing to qualified personnel only.

Notes:

Copyright Information:

- Unauthorised copying, broadcast, public display, transmission, public performance and rental (regardless of whether or not such activities are for profit) of disc contents are prohibited by law.
- This system is equipped with copy protection technology that causes substantial degradation of images when the contents of a disc are copied to a video tape.

Copy Protection:

This unit supports Macrovision copy protection. On DVD discs that include a copy protection code, if the contents of the DVD disc are copied using a VCR, the copy protection code prevents the videotape copy from playing normally.

Apparatus Claims of U.S. Patent Nos. 4,631,603, 4,577,216, 4,819,098, and 4,907,093, licensed for limited viewing uses only.

This product incorporates copyright protection technology that is protected by method claims of certain U.S. patents and other intellectual property rights owned by Macrovision Corporation and other rights owners.

Use of this copyright protection technology must be authorised by Macrovision Corporation, and is intended for home and other limited viewing uses only unless otherwise authorised by Macrovision Corporation.

Reverse engineering or disassembly is prohibited.

Manufactured under license under U.S. Patent #: 5,451,942 & other U.S. and worldwide patents issued & pending. DTS and DTS Digital Out are registered trademarks and the DTS logos and Symbol are trademarks of DTS, Inc. © 1996 - 2007 DTS, Inc. All Rights Reserved.

Manufactured under license from Dolby Laboratories, Dolby, Pro Logic and the double-D symbol are trademarks of Dolby Laboratories.

"HDMI, the HDMI logo and High-Definition Multimedia Interface are trademarks or registered trademarks of HDMI Licensing LLC."

DivX, DivX Certified, and associated logos are trademarks of DivX, Inc. and are used under license.

Manufactured under license under U.S. Patent #'s: 5,451,942; 5,956,674; 5,974,380; 5,978,762; 6,487,535 & other U.S. and worldwide patents issued & pending. DTS and DTS 2.0 + Digital Out are registered trademarks and the DTS logos and Symbol are trademarks of DTS, Inc. © 1996 - 2007 DTS, Inc. All Rights Reserved.

Special Note



Supply of this product does not convey a license nor imply any right to distribute content created with this product in revenue-generating broadcast systems (terrestrial, satellite, cable and/or other distribution channels), revenue-generating streaming applications (via Internet, intranets and/or other networks), other revenue-generating content distribution systems (pay-audio or audio-on-demand applications and the like) or on revenue-generating physical media (compact discs, digital versatile discs, semiconductor chips, hard drives, memory cards and the like). An independent license for such use is required. For details, please visit <http://mp3licensing.com> MPEG Layer-3 audio coding technology licensed from Fraunhofer IIS and Thomson.

NOTE

Audio-visual material may consist of copyrighted works which must not be recorded without the authority of the owner of the copyright. Please refer to the relevant laws in your country.

Accessories

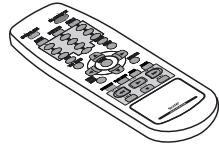
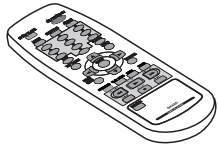
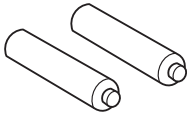
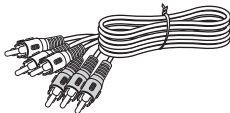
Please confirm that the following accessories are included.

 <p>Remote control x 1 (DV-SL1200W)</p>	 <p>Remote control x 1 (DV-SL2200W)</p>
 <p>"AAA" (UM-4, R03, HP-16 or similar) x 2</p>	 <p>Audio / Video cable x 1</p>
 <p>AC Power lead x 1</p>	

Note:

Only the above accessories are included.

■	Page	■	Page
General Information		Various settings	
Precautions	4	To change the subtitle language	37
Types of playable discs	5	To change the audio language (audio output)	37
Description of discs	6	To change the HDMI resolution type and color (DV-SL2200W only)	38
Controls and indicators	7 - 9	To change the display on TV screen	38
System Connections		Video CD Operation	
Connecting to a conventional TV	10 - 12	Video CD operation	
Connecting to a TV with progressive-scan capability	13 - 14	Playback of a video CD with P.B.C. ON	39
Additional connections	15 - 19	Random play	40
AC power connection	19	To change the audio channel	40
Preparation for Use		CD, CD-R and CD-RW Operation	
Battery installation	20	CD operation	
Turning the power on	20	To play in the desired order (programmed play)	41
Changing the setup menu	21 - 28	To start playback from the desired point (direct play)	42 - 43
DVD Operation		MP3/WMA folder mode (only for MP3/WMA files)	43 - 44
DVD playback		About folder playback order	43
Playback	29	Procedure to playback MP3/WMA disc	44
To resume playback after stopping (resume play)	30	DivX and JPEG disc operation	
DVD mode operation indicators	30	Playback on the DivX and JPEG menu screen	45
Basic operation		Zoom function	46
To locate the beginning of a chapter (track) (skip)	31	Rotating a picture	46
Fast forward/Fast backward (search)	31	USB Memory Playback	
To start playback from the desired point (direct play)	32	USB memory device operation (DV-SL2200W only)	47
To start playback from the desired point by using disc navigator	32	To remove USB memory device	47
Useful operation		References	
Still picture	33	Troubleshooting chart	48 - 49
Step function (Frame by frame playback)	33	Additional information	50
Slow-motion play	33	Error indicators and warnings	51
To change the angle	34	Maintenance	51
To zoom images (zoom)	34	Specifications	52
To play repeatedly (repeat play)	35		
To play the contents between the specified points repeatedly (A-B repeat)	36		
To select a title from the top menu of the disc	36		
To select a subtitle or audio language from the disc menu ...	36		

Precautions

■ General

- Please ensure that the equipment is positioned in a well ventilated area and ensure that there is at least 10 cm (4") of free space along the sides, top and back.

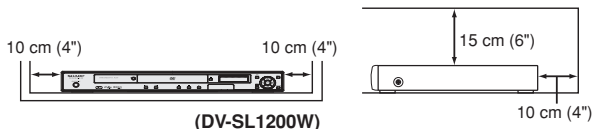

- Use the unit on a firm, level surface free from vibration.

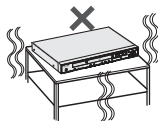

- Keep the unit away from direct sunlight, strong magnetic fields, excessive dust, humidity and electronic/electrical equipment (home computers, facsimiles, etc.) which generate electrical noise.

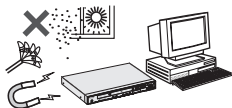

- Do not place anything on top of the unit.
- Do not expose the unit to moisture, to temperatures higher than 60°C (140°F) or to extremely low temperatures.
- If the unit does not work properly, disconnect the AC power lead from the wall socket. Plug it back and turn on the unit.
- In case of an electrical storm, unplug the unit for safety.
- Hold the AC power plug by the head when removing it from the wall socket, as pulling the lead can damage internal wires.
- The AC power plug is used as a disconnect device and shall always remain readily operable.
- **Do not remove the outer cover, as this may result in electric shock. Refer internal service to your local SHARP service facility.**

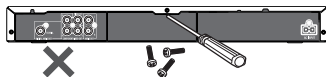

(DV-SL1200W)

- The ventilation should not be impeded by covering the ventilation openings with items, such as newspapers, tablecloths, curtains, etc.

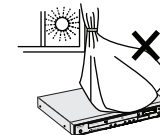

- No naked flame sources, such as lighted candles, should be placed on the apparatus.
- Attention should be drawn to the environmental aspects of battery disposal.
- This unit should only be used within the range of 5°C - 35°C (41°F - 95°F).

Warning:

The voltage used must be the same as that specified on this unit. Using this product with a higher voltage other than that which is specified is dangerous and may result in a fire or other type of accident causing damage. SHARP will not be held responsible for any damage resulting from use of this unit with a voltage other than that which is specified.

■ Care of DVD/CD discs



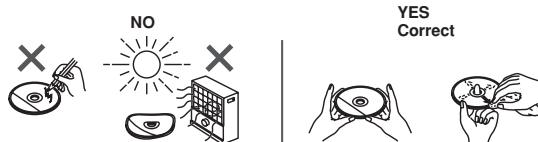

DVD/CD discs are fairly resistant to damage, however mistracking can occur due to an accumulation of dirt on the disc surface. Follow the guidelines below for maximum enjoyment from your DVD/CD collection and player.

- Do not write on either side of the disc, particularly the non-label side from which signals are read. Do not mark this surface.
- Keep your discs away from direct sunlight, heat, and excessive moisture.
- Always hold the DVD/CDs by the edges. Fingerprints, dirt, or water on the DVD/CDs can cause noise or mistracking. If a DVD/CD is dirty or does not play properly, clean it with a soft, dry cloth, wiping straight out from the centre, along the radius.



Types of playable discs

The DVD player can play back discs bearing any of the following marks:

Disc type	Disc contents
DVD Video Disc 	Audio and video (movies)
Video CD 	Audio and video (movies)
Audio CD 	Audio
CD-R/CD-RW (*1)  Or CD-R/CD-RW recorded in JPEG format (*2)	Audio, picture and video
DivX® Video disc 	Audio and video (movies)

(*1): The CD-R/CD-RW may not be played back properly depending on the recording equipment or the disc.

(*2): JPEG or JPG picture discs also play on this unit. However, pictures may not be clear (depends on resolution and recording method).

● For unplayable discs, see page 6.

Types of playable DVD discs vary depending on the region. This unit can play back only DVDs with the same region number as written on the back of the unit.

(DV-SL1200W)

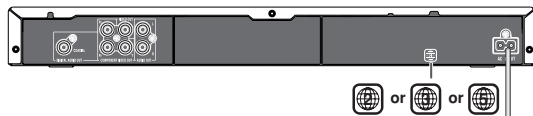



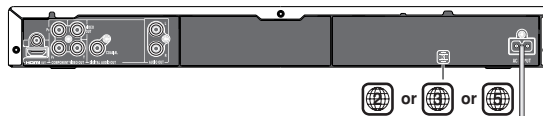

(DV-SL2200W)



Icons used in this operation manual

Some functions may not be available depending on discs. The following icons indicate the discs that can be used in the section.

-  ... Indicates DVDs.
-  ... Indicates video CDs.
-  ... Indicates audio CDs.
-  ... Indicates CD-R/RW with JPEG recording.
-  ... Indicates DivX® Video.

- Some operations may not be performed depending on discs even if they are described in this manual.
- During operation, "Depending on the disc, this operation may be prohibited" or "This operation cannot be performed" may be displayed on the screen. This means that the operations described in this manual are not possible.

Copyright Information:

- Unauthorised copying, broadcast, public display, transmission, public performance and rental (regardless of whether or not such activities are for profit) of disc contents are prohibited by law.
- This system is equipped with copy protection technology that causes substantial degradation of images when the contents of a disc are copied to a videotape.
- This system is protected by U.S. patents and other intellectual property rights, the copyright for which belongs to Macrovision Corporation. The use of Macrovision's copy protection technology in the system is authorised by Macrovision and is intended for home use only, unless otherwise authorised in writing by Macrovision. Reverse engineering or disassembly is prohibited.

Description of discs

Discs that cannot be played

- DVDs without the region number on the back of the unit or "ALL".
 - DVDs with SECAM system
 - DVD-ROM
 - DVD-RAM
 - DVD-Audio
 - CDG
 - CDV
 - Photo CD
 - CD-ROM
 - SACD
 - Discs recorded in special formats, etc.
- The discs above cannot be played at all, or no sound is heard although images appear on the screen or vice versa.
 - You cannot play illegally produced discs.

Notes:

- A disc which has scratches or fingerprints may not play properly. Refer to "Care of DVD/CD discs (page 4)" and clean the disc.
- Do not play the discs of special shapes (heart or octagon shaped) as they can be ejected whilst rotating and cause injury.

Title, chapter and track

DVDs are divided into "titles" and "chapters". If the disc has more than one movie on it, each movie is a separate "title". "Chapters" are subdivisions of titles.

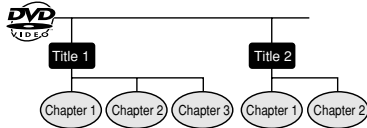

Audio CDs consist of "tracks".
A "track" is each tune on an audio CD.



Note:

Title, chapter, or track numbers may not be recorded on some discs.

Icons used on DVD discs

Check the icons on the DVD case before playing your discs.

Display	Description
Region number (playable area number) 	DVD discs are programmed with region numbers indicating countries in which they can be played. This system can play discs with region number on the back of the unit.
Format recorded on the DVD	To adopt the video format to the connected TVs ("wide-screen TV" or "4:3 size TV").
	Recorded in 4:3.
	You can enjoy wide images on a wide-screen TV, and letterbox size images on the 4:3 size TV.
	You can enjoy wide images on a wide-screen TV and 4:3 images with the side edges cut on the 4:3 size TV.
Type of subtitles recorded Example: 1: English 2: French	Recorded subtitle languages. Language can be selected with the SUBTITLE button.
Number of camera angles 	Number of angles recorded on the DVD. Angles can be selected with the ANGLE button.
Number of audio tracks and audio recording systems Example: 1: Original <English> (DTS 5.1 Surround) 2: English (Dolby Digital 5.1 Surround)	The number of audio tracks and audio recording systems are indicated. ● The audio recorded on the DVD can be switched by using the AUDIO button. ● The number of audio tracks and recording systems vary depending on the DVD. Check them in the DVD's manual.

Controls and indicators

■ Main unit (front panel) (DV-SL1200W)

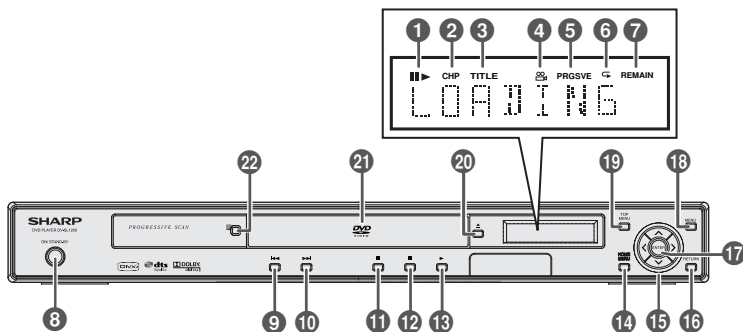

■ Main unit (front panel) (DV-SL2200W)

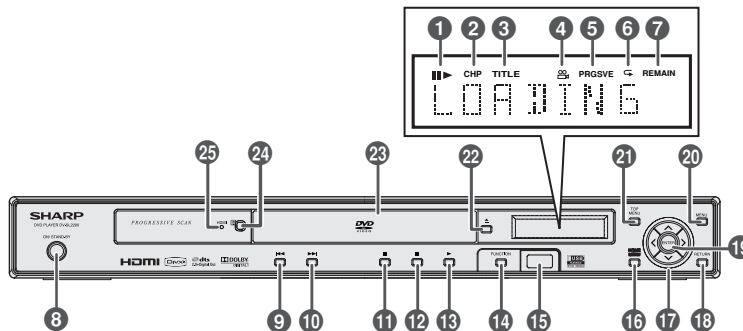

Reference page

1)	Play and Pause Indicator	30
2)	Chapter Indicator	30
3)	Title Indicator	30
4)	Angle Indicator	30
5)	Progressive-scan Indicator	30
6)	Repeat Indicator	30
7)	Remain (Time) Indicator	30
8)	ON/STAND-BY Button	20
9)	Chapter (track) Skip Down Button	31, 39
10)	Chapter (track) Skip Up Button	31, 39
11)	Stop Button	29, 30
12)	Pause Button	29, 30
13)	Play Button	29, 30
14)	Home Menu Button	21, 37
15)	Cursors	34, 45
16)	Return Button	39
17)	Enter Button	27, 32, 35
18)	Menu Button	36, 45
19)	Top Menu Button	36
20)	Disc Tray Open/Close Button	29
21)	Disc Tray	29
22)	Remote Sensor	20

Reference page

1)	Play and Pause Indicator	30
2)	Chapter Indicator	30
3)	Title Indicator	30
4)	Angle Indicator	30
5)	Progressive-scan Indicator	30
6)	Repeat Indicator	30
7)	Remain (Time) Indicator	30
8)	ON/STAND-BY Button	20
9)	Chapter (track) Skip Down Button	31, 39
10)	Chapter (track) Skip Up Button	31, 39
11)	Stop Button	29, 30
12)	Pause Button	29, 30
13)	Play Button	29, 30
14)	DVD/USB Function Select Button	47
15)	USB Terminal	47
16)	Home Menu Button	21, 37
17)	Cursors	34, 45
18)	Return Button	39
19)	Enter Button	27, 32, 35
20)	Menu Button	36, 45
21)	Top Menu Button	36
22)	Disc Tray Open/Close Button	29
23)	Disc Tray	29
24)	Remote Sensor	20
25)	HDMI Indicator	19

■ Main unit (rear panel) (DV-SL1200W)

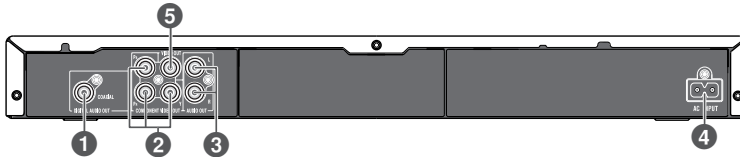

Reference page

1) Digital Audio Output Socket (Coaxial)	16
2) Component Video Output Sockets	10, 13
3) Audio Output Sockets	15
4) AC Power Input Socket	19
5) Video Output Socket	15

■ Main unit (rear panel) (DV-SL2200W)

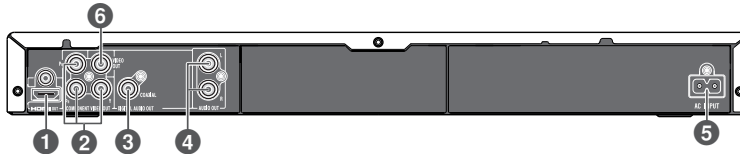

Reference page

1) HDMI Output Socket	19
2) Component Video Output Sockets	10, 13
3) Digital Audio Output Socket (Coaxial)	16
4) Audio Output Sockets	15
5) AC Power Input Socket	19
6) Video Output Socket	15

Controls and indicators (continued)

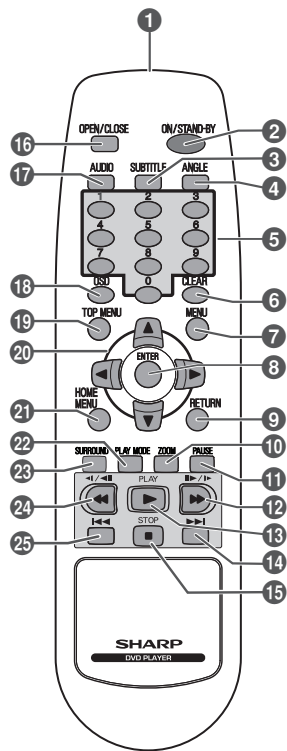

(DV-SL1200W)

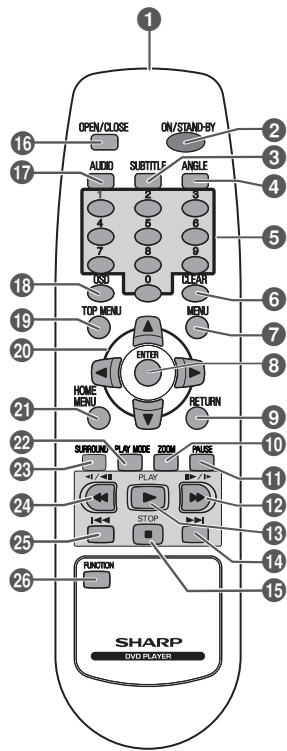

(DV-SL2200W)

Remote control

	Reference page
1. Remote Control Transmitter	20
2. On/Stand-by Button	21, 29
3. Subtitle Select Button	37
4. Angle Select Button	34
5. Direct Number Buttons	31, 32, 39, 42
6. Clear Button	41
7. Menu Button	35, 36, 45
8. Enter Button	21, 42, 44
9. Return Button	39
10. Zoom Button	34, 46
11. Pause Button	33
12. Step Forward, Fast Forward and Slow Forward Button	31, 33
13. Play Button	29, 31, 33, 39, 44
14. Chapter (track) Skip Up Button	31, 39
15. Stop Button	29, 30, 35, 39
16. Disc Tray Open/Close Button	29
17. Audio Select Button	37
18. On Screen Display On/Off Button	38
19. Top Menu Button	36
20. Cursors	21, 34, 35, 41, 42, 44, 45
21. Home Menu Button	21
22. Play Mode Button	42
23. Surround Button	22
24. Step Backward, Fast Backward and Slow Backward Button ..	31, 33
25. Chapter (track) Skip Down Button	31, 39
26. DVD/USB Function Select Button	47

(For model DV-SL2200W only)

Connecting to a conventional TV

Connect the DVD player to your TV.

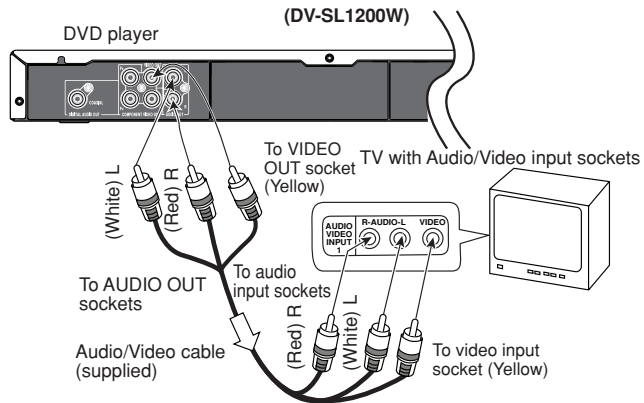

Notes:

- Please refer to your TV instruction manual.
- When you connect the DVD player to your TV, be sure to turn off the power and disconnect both units from the wall socket until all the connections have been made.
- If your TV has one audio input socket, connect the AUDIO OUT sockets of the DVD player to a Y-cable adaptor (not supplied), then connect it to the TV Audio input. Please consult your local audio/video dealer.
- Do not connect the DVD player to a VCR directly. The playback picture will be distorted because DVD discs are copy protected.

Using the COMPONENT VIDEO OUT sockets

Notes:

Please follow the steps before turn on the power.

1. If your TV has the component video input sockets, connect the DVD player to these sockets. (The VIDEO OUT socket connection is not necessary.) You can enjoy high quality picture playback.
2. You also need to connect the left and right audio cables to the AUDIO OUT sockets of DVD player and the Audio input sockets of the TV.

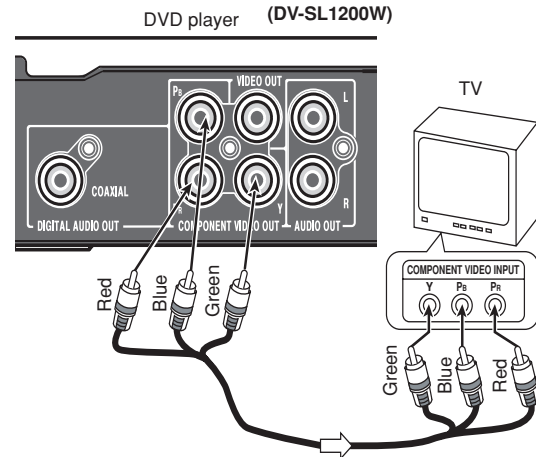

Connecting to a conventional TV (continued)

Using RF Modulator

If your TV does not have a Video input socket and has an aerial terminal only, please purchase the *RF Modulator (not supplied).
(*Please consult your audio/video dealer.)

Example: DVD player, TV and RF Modulator connections

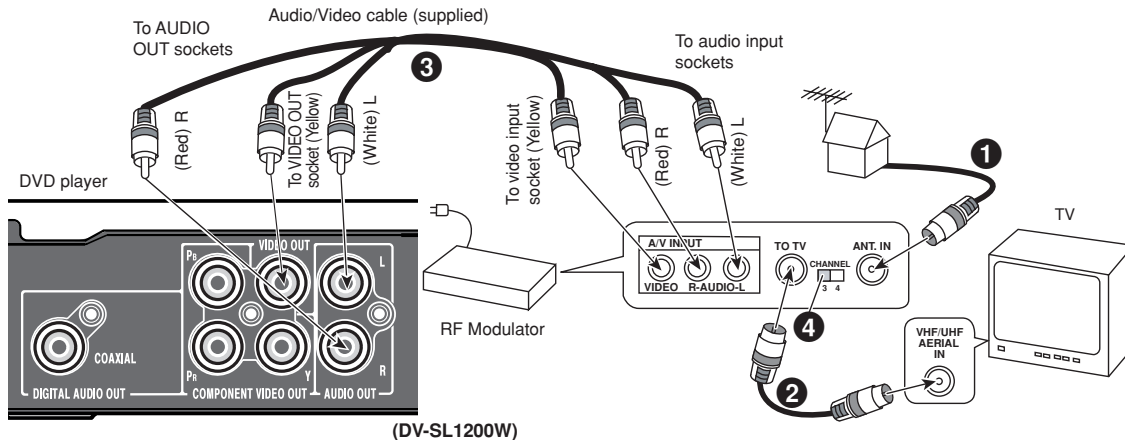

1. Connect the aerial cable (not supplied) to the ANT. IN terminal of the RF Modulator.
2. Connect the 75-ohm coaxial cable (not supplied) between the TO TV terminal of the RF Modulator and the VHF/UHF AERIAL IN terminal of the TV.
3. Connect the Audio/Video cable (supplied) between the AUDIO OUT and VIDEO OUT sockets of the DVD player and the AUDIO INPUT and VIDEO INPUT sockets of the RF Modulator.

4. Turn on the TV, and set the channel number (CHANNEL 3 or CHANNEL 4) on both TV and RF Modulator, whichever is not used for regular broadcast in your area.

Note:

For more details, please refer to the instruction manual of the RF Modulator.

Example: DVD player, VCR, TV and RF Modulator connections

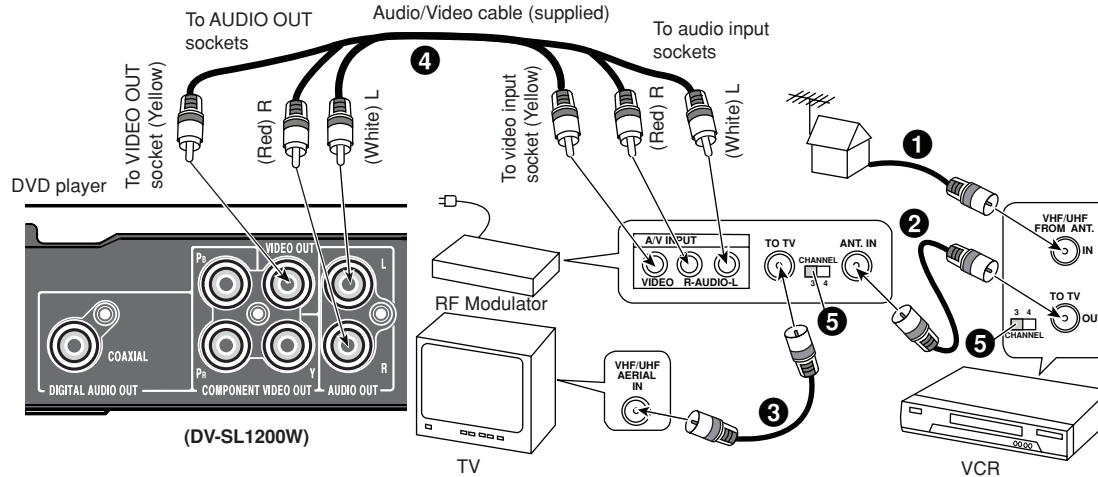

1. Connect the aerial cable (not supplied) to the VHF/UHF FROM AERIAL IN terminal of the VCR.
2. Connect the 75-ohm coaxial cable (not supplied) between the TO TV OUT terminal of the VCR and the ANT. IN terminal of the RF Modulator.
3. Connect the 75-ohm coaxial cable (not supplied) between the TO TV terminal of the RF Modulator and the VHF/UHF AERIAL IN terminal of the TV.

4. Connect the Audio/Video cable (supplied) between the AUDIO OUT and VIDEO OUT sockets of the DVD player and the AUDIO INPUT and VIDEO INPUT sockets of the RF Modulator.
5. Turn on the TV, and set the channel number (CHANNEL 3 or CHANNEL 4) on all TV, VCR and RF Modulator, whichever is not used for regular broadcasts in your area.

Note:

For more details, please refer to the instruction manual of the RF Modulator.

Connecting to a TV with progressive-scan capability

Your TV must be capable of handling progressive scanning and have component video input capability.

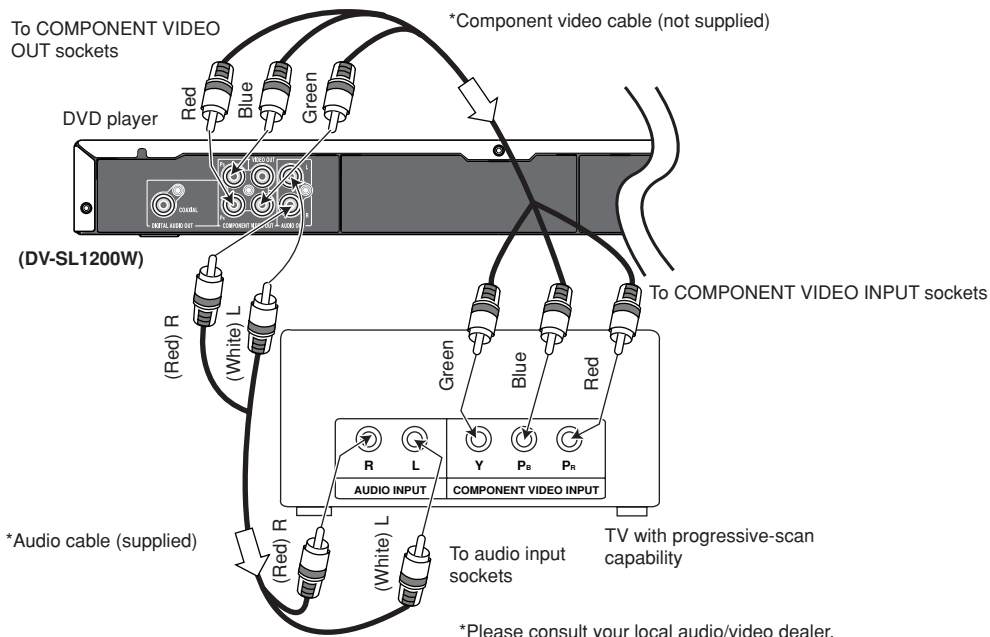

*Please consult your local audio/video dealer.

1. Connect the DVD player to the component video input sockets of the TV. (The VIDEO OUT sockets connection is not encourage.)
2. You also need to connect the left and right audio cables to the AUDIO OUT sockets of DVD player and the Audio input sockets of the TV.
3. Set the DVD player to the PROGRESSIVE position. (See page 14)

Note:

Reset the component setting to INTERLACE using front panel controls.

- To perform reset function, see "Clearing all the memory (reset)" on page 49.

Interlaced scanning**Progressive scanning****Progressive scanning**

Whilst interlaced scanning produces one frame of video in two fields, progressive scanning creates one frame in one field.

Conventional interlaced scanning constitutes one second with 30 frames (60 fields), but progressive scanning constitutes it with 60 frames from scratch.

Progressive scanning can reproduce sharper picture with high resolution for still image or other picture containing long texts or horizontal lines.

This model has compliance with 576p (progressive) system.

Notes:

- Please refer to your TV instruction manual.
- When you connect the DVD player to your TV, be sure to turn off the power and disconnect both units from the wall socket until all the connections have been made.
- Do not connect the DVD player to a VCR directly. The playback picture will be distorted because DVD video discs are copy protected.

Notes:

- **For VIDEO connection, please refer to “System Connections”.**
- Please refer to the instruction manual of your amplifier.
- When you connect the DVD player to your amplifier, be sure to turn off the power and disconnect both units from the wall socket until all the connections have been made.

Additional connections

■ Connecting to an Audio System and TV

Connect the DVD player to an Audio System and a TV.

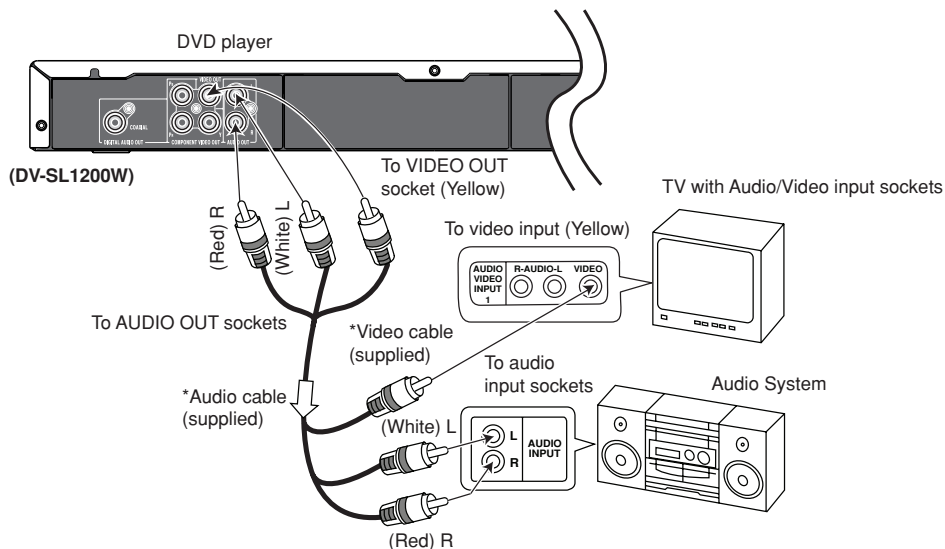

* Please consult your local audio/video dealer.

Notes:

- Please refer to the instruction manual of your Audio System and TV.
- When you connect the DVD player to other equipment, be sure to turn off the power and disconnect all of the equipment from the wall socket until all the connections have been made.
- Do not connect the DVD player to a VCR directly. The playback picture will be distorted because DVD discs are copy protected.

■ Connecting to an Amplifier with Dolby Digital Decoder or DTS Decoder

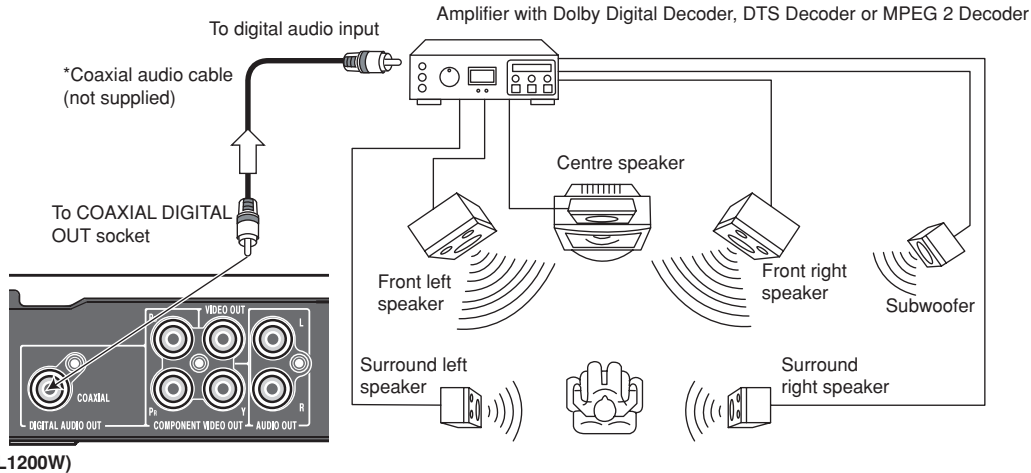

To enjoy Dolby Digital or DTS

Select "On" in "Digital Out" on the "Digital Audio Out" (See page 23).

* Please consult your local audio/video dealer.

Additional connections (continued)

■ Connecting to a Digital Amplifier

You can enjoy 2 Channel Digital Stereo Sound.

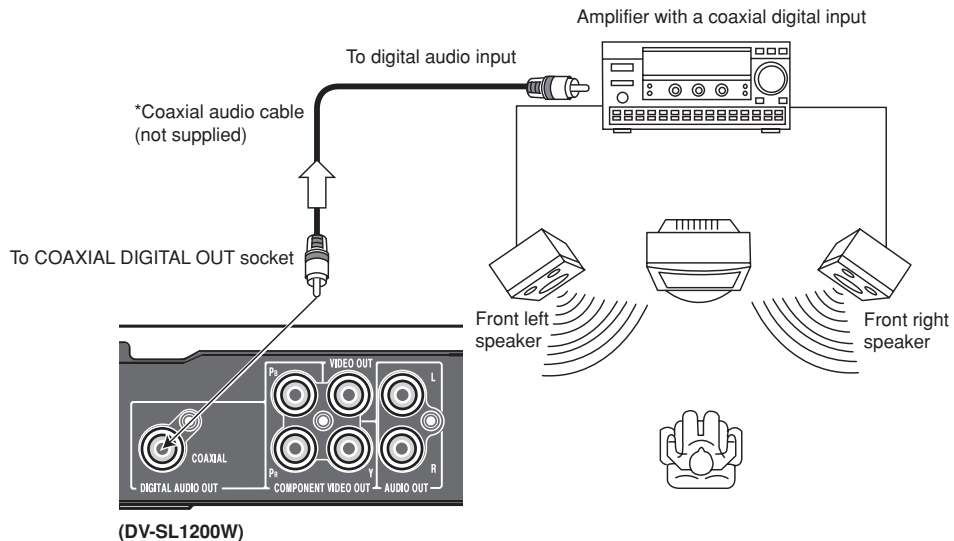

To enjoy 2 Channel Digital Stereo sound

Select "PCM" in "Digital Audio Out" on the "Initial Settings". (See page 23)

* Please consult your local audio/video dealer.

■ Connecting to an Amplifier with Dolby Pro Logic Decoder

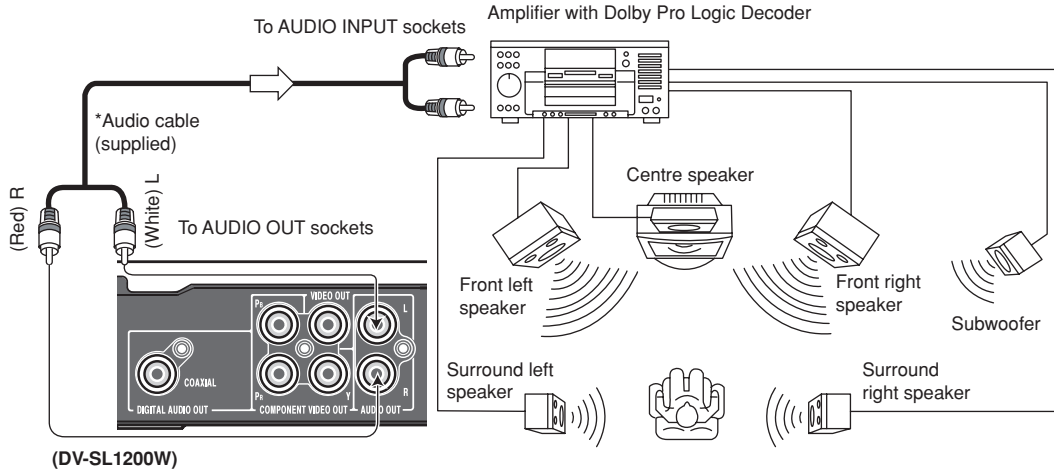

Note:

Please refer to your amplifier instruction manual.

* Please consult your local audio/video dealer.

Additional connections (continued)

■ Connecting to a TV with HDMI socket (DV-SL2200W)

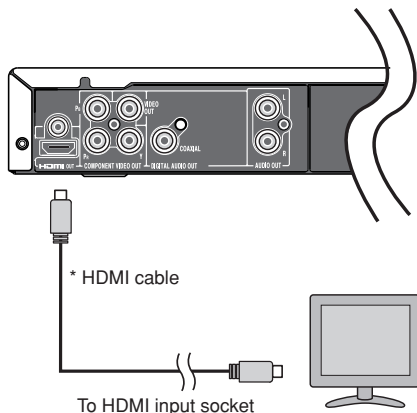

Note:

Please follow the below steps before turn on the power.

1. If your TV has the HDMI input socket, connect the DVD player with the HDMI cable. (The VIDEO OUT and COMPONENT VIDEO OUT sockets connection are not necessary.) You can enjoy clearer picture playback.
2. You no need to connect the left and right audio cables to the AUDIO OUT socket of DVD player and the AUDIO INPUT socket of TV.

Note:

Reset the HDMI resolution to default setting using front panel controls.

- To perform reset function, see "Clearing all the memory (reset)" on page 49.

AC power connection

■ Connecting the AC power lead

After checking all the connections have been made correctly, connect the supplied AC power cable to the AC INPUT socket, then plug into the wall socket.

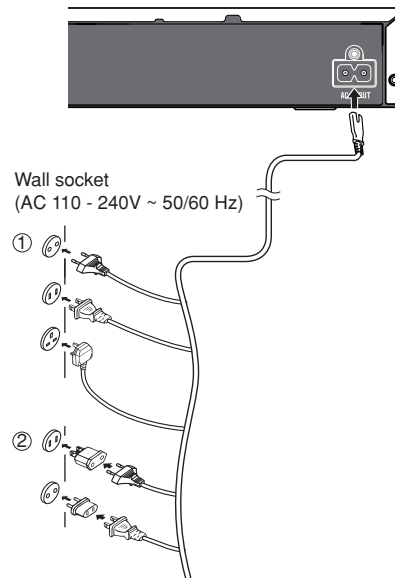

Note:

Unplug the AC power lead from the wall socket if the unit will not be used for a prolonged period of time.

AC Plug Adaptor

In areas (or countries) where a wall socket as shown in illustration ② is used, connect the unit using the AC plug adaptor supplied with the unit, as illustrated. The AC plug adaptor is not included in areas where the wall socket and AC power plug can be directly connected (see illustration ①).

Battery installation

- 1 Open the battery cover.
- 2 Insert the supplied batteries according to the direction indicated in the battery compartment.
When inserting or removing the batteries, push them towards the ⊖ battery terminals.
- 3 Close the cover.

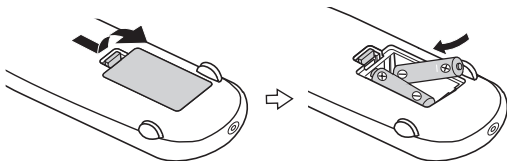

Precautions for battery usage:

- Replace all old batteries with new ones at the same time.
- Do not mix old and new batteries.
- Remove the batteries if the unit is not to be used for long periods of time.
This will prevent potential damage due to battery leakage.

Caution:

- Do not use rechargeable batteries (nickel-cadmium battery, etc.).
- Incorrect installation may cause the unit to malfunction.
- Batteries (battery packed or batteries installed) shall not be exposed to excessive heat such as sunshine, fire or the like.

Notes concerning usage:

- Replace the batteries if the operating distance is reduced or if the operation becomes erratic. Purchase 2 "AAA" size batteries (UM-4, R03, HP-16 or similar).
- Periodically clean the transmitter on the remote control and the sensor on the unit with a soft cloth.
- Exposing the sensor on the unit to strong light may interfere with operation. Change the lighting or the direction of the unit.
- Keep the remote control away from moisture, heat, shock, and vibrations.

Turning the power on

DV-SL1200W
DV-SL2200W

■ Test of the remote control

Check the remote control operation after making all the connections. Point the remote control directly at the remote sensor on the unit.

The remote control can be used within the range shown below:

Press the ON/STAND-BY button. Does the power turn on? Now, you can enjoy your system.

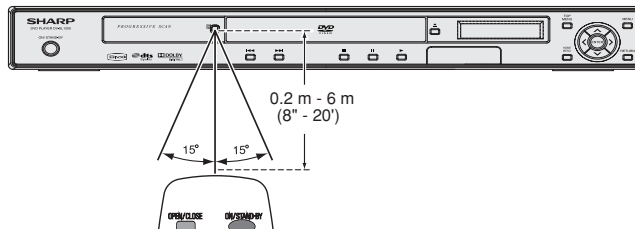

■ To turn the power on



Press the ON/STAND-BY button.

If the power does not turn on, check the AC power lead is plugged in properly.

Changing the setup menu

Turn on the TV, and switch the input to the "VIDEO 1", "VIDEO 2", etc. accordingly.

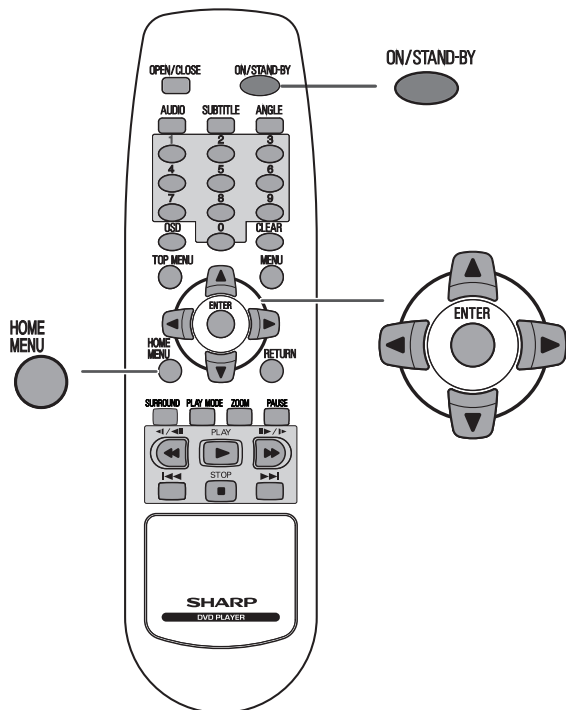

1 Press the ON/STAND-BY button to turn the power on.

The startup screen appears.



2 Press the HOME MENU button.

3 Press the ▲, ▼, ◀ or ▶ button to select a menu and press the ENTER button.

See the list on pages 22 - 28 for setup menu.

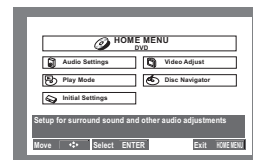

4 Press the ▲, ▼, ◀ or ▶ button to change the setting and press the ENTER button.

- See the list on pages 22 - 28 for the selectable parameters.
- Press the RETURN button to return to the main pages.

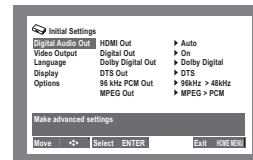

5 Press the HOME MENU button.

- The setting is completed.
- To change other settings, begin from step 2.

Notes:

- During playback, "Initial Settings" cannot be changed.
- Settings are stored even if the unit is set to the stand-by mode.
- The backup function protects the stored settings for a few hours should there be a power failure or the AC power lead disconnection.

■ Change the system to a TV with Progressive-Scan

If you use TV with Progressive-Scan capability and connect it to the COMPONENT VIDEO OUT sockets of the DVD main unit (see page 13), you can select to "Progressive" at "Video Output, Component Out" in the "Initial Settings" menu for progressive-scan.

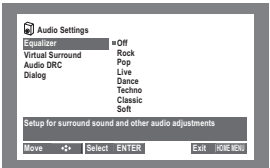
Setup menu	Selectable parameters (* indicates default settings.)	Description
Audio Settings 	Equalizer * Off Rock Pop Live Dance Techno Classic Soft	You can change the sound effect. The various preset EQ curves are designed to suit various styles of music.
	Virtual Surround * On * Off	Switch on the Virtual Surround to enjoy surround sound effects. (*1)
	Audio DRC High Medium Low * Off	If adjusting to High, the audio signal peak value will be minimum, whilst adjusting to Off, maximum. (*2)
	Dialog High Medium Low * Off	To make the dialog sound stand out from background sound in the soundtrack.

Notes:

(*1) During playback of DTS discs, you can enjoy the virtual surround feature for DTS (PCM) output. (DV-SL2200W only)

(*2) Selects the dynamic range compression to fit the individual listening situation of the audience.

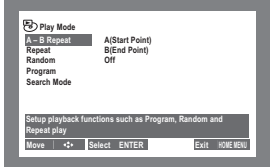
Setup menu	Selectable parameters (* indicates default settings.)	Description
Play Mode 	A - B Repeat A (Start Point) B (End Point) Off	You can play the desired portion repeatedly by specifying it during playback. (*1)
	Repeat Title Repeat Chapter Repeat Repeat Off	You can select repeat play options. This function depending on the disc loaded. (*1)
	Random Random Title Random Chapter Random Off	The titles or chapter (DVD) or tracks (CD,VCD) discs can be played in Random order automatically. (*2)
	Program Create/Edit Playback Start Playback Stop Program Delete	You can playback the desired titles or chapters (DVD) or tracks (CD,VCD) in a specific order. (*2)
	Search Mode Title Search Chapter Search Time Search	You can search DVD discs by title or chapter number or by time. CD and VCD by track number or time. DivX video discs by time. (*3)

Notes:



(*1) A - B Repeat and Repeat function cannot be use if VCD play in P.B.C. mode or MP3/WMA/MPEG-4 AAC files.

(*2) Random and Programme play function cannot be use if DVD-R/-RW discs in VR format. VCD playing in P.B.C. mode, DivX video discs, or whilst a DVD disc menu is being displayed.

(*3) Search functions cannot be use if VCD play in P.B.C. mode or MP3/WMA/MPEG-4 AAC discs.

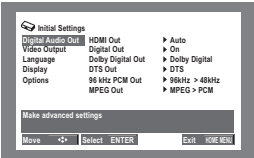
Changing the setup menu (continued)

Setup menu	Selectable parameters (* indicates default settings.)	Description	
Initial Settings 	Digital Audio Out	HDMI Out (DV-SL2200W only) * Auto Off	Digital audio is downmix to 2 channels for stereo linear PCM output.
		Digital Out * On Off	Select the digital output terminal.
		Dolby Digital Out * Dolby Digital Dolby Digital > PCM	Convert the Dolby Digital audio signal to PCM audio before being output.
		DTS Out * DTS DTS > PCM (DV-SL2200W only)	Convert the DTS audio signal to PCM audio before being output.
		96 kHz PCM Out * 96kHz > 48kHz 96kHz	Convert the 96kHz signal to 48kHz for digital output.
		MPEG Out * MPEG * MPEG > PCM	Convert the MPEG audio to PCM for digital output.
	Video Output	TV Screen * 4:3 (Letter Box) 4:3 (Pan & Scan) 16:9 (Wide) 16:9 (Compressed) (DV-SL2200W only)	The screen mode should be set according to the connected TV type. (for more details, see page 26)
		Component Out * Progressive Interlace	Select the Interlace if your TV not compatible with Progressive Scan.
		HDMI Resolution (DV-SL2200W only) 1920 X 1080P 1920 X 1080I 1280 X 720P * 720 X 480P 720 X 480I	To select HDMI resolution.
		HDMI Color (DV-SL2200W only) Full Range RGB RGB * Component	To select HDMI colour.

Setup menu	Selectable parameters (* indicates default settings.)			Description
Initial Settings	Language	Audio Language	* English Spanish Chinese Thai Other Language	To select language audible from the speaker.
		Subtitle Language	* English Spanish Chinese Thai Other Language	To select the subtitle displayed on the TV screen.
		DVD Menu Lang.	* w/Subtitle Lang. English Spanish Chinese Thai Other Language	To select the DVD menu language.
		Subtitle Display	* On Off	
	Display	OSD Language	* English Español 汉语 ไทย	<p>You can select the desired OSD (On Screen Display) language for the set up menu or playback control screen. Example: To select Spanish language, choose "Español" from the menu. Press ENTER button and below screen will appear in Spanish.</p> 
		Angle Indicator	* On Off	
	Options	Parental Lock	Password Level Change Country Code	Default password: none Default level: off Default Country/Area code: US (2119)
		DTS Downmix (DV-SL2200W only)	* Stereo (Lt/Rt)	
		DivX VOD	Display	 <p>SHARP provides you the DivX registration code that allows you to rent and purchase video from the internet. Please go to www.divx.com/vod for more information.</p>



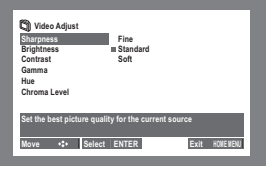

Changing the setup menu (continued)

Setup menu	Selectable parameters (* indicates default settings.)		Description
Video Adjust		Sharpness * Fine Standard Soft	To adjust TV screen sharpness of edges in the picture.
		Brightness ▶ Standard ▶ 0 ▶ 0 ▶ 0 ▶ 0 ▶ 0	To adjust TV screen overall brightness level. After press ENTER button, press ◀ or ▶ button to adjust the brightness from min (-20) to max (+20).
		Contrast ▶ Standard ▶ 0 ▶ 0 ▶ 0 ▶ 0 ▶ 0	To adjust TV screen contrast level. After press ENTER button, press ◀ or ▶ button to adjust the contrast from min (-16) to max (+16).
		Gamma ▶ Standard ▶ 0 ▶ 0 ▶ 0 ▶ 0 ▶ 0	To adjust TV screen "gradation". After press ENTER button, press ◀ or ▶ button to adjust the gamma from min (-3) to max (+3).
		Hue ▶ Standard ▶ 0 ▶ 0 ▶ 0 ▶ 0 ▶ 0	To adjust TV screen red/green balance. After press ENTER button, press ◀ or ▶ button to adjust the hue level from green 9 to red 9.
		Chroma Level ▶ Standard ▶ 0 ▶ 0 ▶ 0 ▶ 0 ▶ 0	To adjust TV screen saturated colours. After press ENTER button, press ◀ or ▶ button to adjust the chroma level from min (-9) to max (+9).
Disc Navigator			See page 32 for detail.

Note:

Press ENTER to return to the Video Adjust screen, or HOME MENU to exit.





■ TV display setting

Indicator	Setting
4:3 (Letter Box)	<p>When playing a wide image (16:9) disc, black bands are inserted at the top and bottom and you can enjoy full wide images (16:9) on a 4:3 size TV.</p>  <p>A 4:3 disc is played in 4:3.</p>
4:3 (Pan & Scan)	<p>When playing a wide image (16:9) disc, the left and right sides of the image are cut (pan scan) to display a natural-looking 4:3 size image.</p> <p>A wide image disc without pan scan [PS] is played back in 4:3 letterbox.</p>  <p>A 4:3 disc is played in 4:3.</p>
16:9 (Wide)	<p>A wide image (16:9) is displayed when playing a wide image (16:9) disc.</p>  <ul style="list-style-type: none"> ● When playing a 4:3 image disc, the image size depends on the setting of the connected TV. ● If you play back a wide image (16:9) disc with this unit connected to a 4:3 TV, the vertically shrunk image is displayed.
16:9 (Compressed) (DV-SL2200W only)	<p>When play 4:3 disc with this unit connected to a 16:9 TV (wide screen TV), the horizontally expanded image is displayed. If you use this setting, a natural looking image 4:3 size can be viewed with the black bands are inserted at the left and right of the screen.</p>  <ul style="list-style-type: none"> ● If you playback a wide image (16:9) disc with 4:3 TV, the vertically shrunk image is displayed.

Note:

When playing the disc with a fixed video format, it will not change even if the TV screen size is changed.

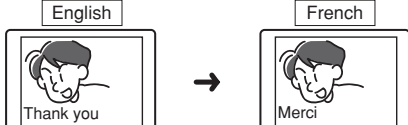
■ Language setting

Indicator	Setting
OSD Language	<p>A language for screen display can be set for the setup menu, messages, etc.</p> 
Audio Language	<p>A language for audio can be set. You can specify a language for conversation and narration.</p> 
Subtitle Language	<p>A language for subtitle can be set. The subtitles are displayed in a specified language.</p> 
DVD Menu Lang.	<p>A language for disc menus can be set. Menu screens are displayed in a specified language.</p> 

Changing the setup menu (continued)

■ Parental lock

- To control over what your children watch on your DVD player, some DVD discs feature a Parental Lock level.
- If your player is set to a lower level than the disc, the disc would not play.
- The player does not play certain scenes on some discs that support the Country/Area Code feature, depending on the Country/Area Code you set.
- Not all discs use Parental Lock and will play without requiring the password first.
- If you forget your password, you will need to reset the player to register a new password. (See "Clearing all the memory (reset)" on page 49).

■ Password setting

You must register a password before you can change the Parental Lock level or enter a Country code.

- 1 Whilst in the stop mode, press HOME MENU then select "Initial Settings" and press ENTER button.

- 2 Initial Settings menu will appear. Select "Options", "Parental Lock" then "Password" by each time press ENTER button.

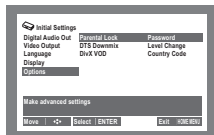

- 3 Use the Direct Number buttons to enter a 4-digits password.

- The numbers you enter show up as asterisks (*) on screen.

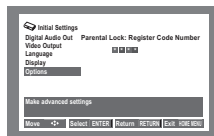

- 4 Press ENTER button to register the password.

- You will return to the "Initial Settings" menu screen.

■ Changing your password

To change your password, confirm your existing password then enter a new one.

- 1 Repeat steps 1 and 2 in "Password setting" but this time select "Password Change".

- 2 Use the Direct Number buttons to enter your existing password, then press ENTER button.

Enter a new password and press ENTER button.

- This registers the new password and you will return to the "Initial Settings" menu screen.

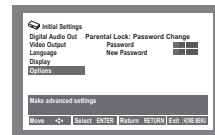

■ Setting/changing the parental lock

- 1 Repeat steps 1 and 2 in "Password setting" but this time select "Level Change".

- 2 Use the Direct Number buttons to enter your password, then press ENTER button.

- 3 Select a new level by pressing ◀ or ▶ button then press ENTER button.

- Press ◀ button repeatedly to lock more levels (more discs will require the password).
- Press ▶ button to unlock levels. You cannot lock level 1.
- This sets the new level and you will return to the "Initial Settings" menu screen.

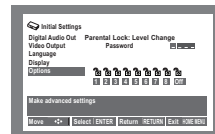

Indicator	Setting
1 KID SAFE	Only DVD software intended for children can be played back.
2G to 7 NC-17	Only DVD software intended for general use and children can be played back.
8 ADULT	DVD software of any grade (adult/general/children) can be played back.

Note:

Whilst playing a disc with parental lock, the display may appear restricted statement screens. In such case, eject the disc and return to "Initial Settings" to change the parental level.

■ **Setting/changing the Country/Area code**

You can find the Country/Area code list on page 50.

- 1 Repeat step 1 and 2 in "Password setting" but this time select "Country Code".**
- 2 Use the Direct Number buttons to enter your password, then press ENTER button.**
- 3 Select a Country/Area code by pressing ◀, ▶, ▲ or ▼ button then press ENTER button.**
There are two ways you can select the Country/Area code:
 - Use ▲ or ▼ button to change the Country/Area code by select code letter.
 - Select by code number; press ▶ button then use the Direct Number buttons to enter the 4-digit Country/Area code.
 - The new Country/Area code is set and you will return to the "Initial Settings" menu screen.

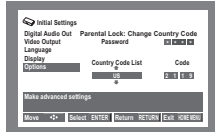

Note:

The new Country/Area code does not take effect until the next disc is loaded or the current disc is reloaded.

■ **Selecting languages using the language code list**

Some of the languages options such as "DVD Menu Lang." in the "Initial Settings" allow you to set your preferred language from any of the 136 languages listed in the language code list on page 50.

- 1 From "Initial Settings" menu screen, select "Language" then press ENTER button.**
- 2 Select "Other Language" from "Audio Language", "Subtitle Language" or "DVD Menu Lang." then press ENTER button.**
- 3 Use the ◀, ▶, ▲ or ▼ button to select either a code letter or a code number then press ENTER button.**
This sets the languages using and you will return to the "Initial Settings" menu screen.

■ **TV system setting**

You can select a TV system to match your country or region's system.

Whilst the main set is off, press and hold the ►► button at the front panel controls. Then press ON/STAND-BY button to switch the TV system.
The TV system changes as follows:

AUTO → NTSC → PAL
 ↑

Notes:

- The default setting of this player is AUTO. You should leave it set to AUTO unless you notice that the picture is distorted when playing some discs.
- You have to switch the player into stand-by mode before each change.
- The TV system may not be changed whilst playback mode.

DVD playback

Turn on the TV, and switch the input to the "VIDEO 1", "VIDEO 2", etc. accordingly.

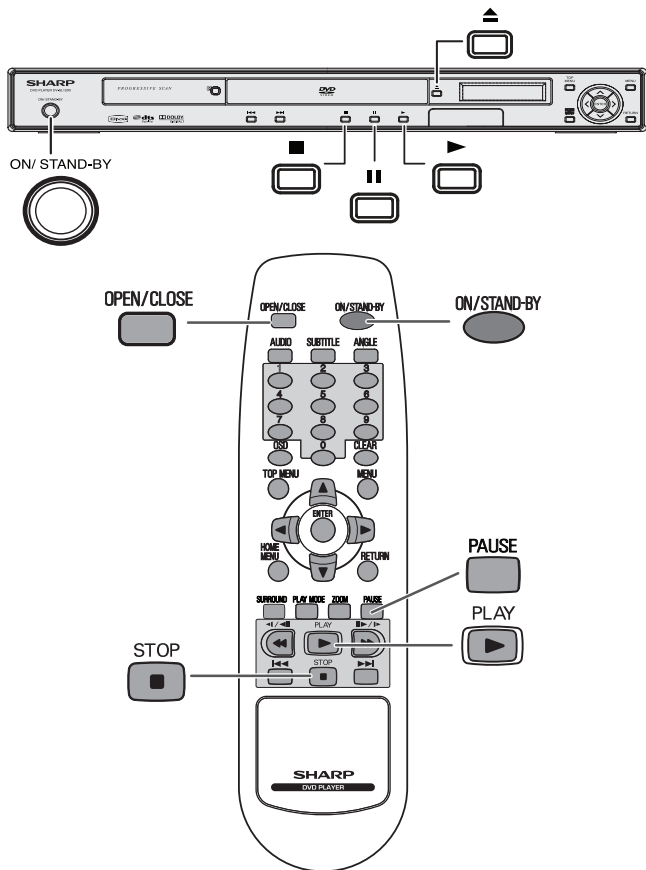

■ Playback DVD CD JPEG DivX

- 1 Press the ON/STAND-BY button to turn the power on.
- 2 Startup screen appears on the TV screen.



- 3 Press the ▲ (OPEN/CLOSE) button to open the disc tray.
- 4 Place the disc on the disc tray, label side up.

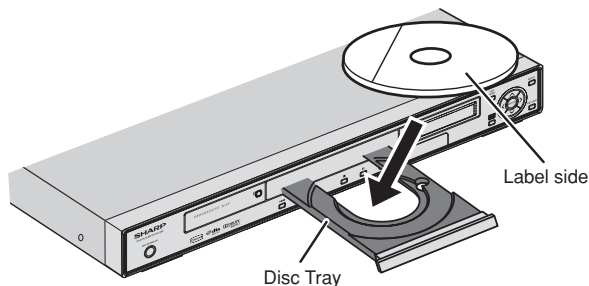

Be sure to place 8 cm (3") discs in the middle of the disc position.

- 5 Press the ▲ (OPEN/CLOSE) button to close the disc tray.
Discs supporting auto start will start to play once you close the disc tray even if you do not press the ► (PLAY) button.

- 6 If playback does not start in step 5, press the ► (PLAY) button.

To interrupt playback

Press the **II** (PAUSE) button.

To resume playback from the same point, press the **▶** (PLAY) button.

To stop playback

DVD/Audio CD/VCD/DivX:

Press the **■** (STOP) button twice.

When the unit is left unoperated for more than 5 minutes after pressing the **■** (STOP) button, a screen saver appears.

Press any button on the main unit or remote control. The startup screen returns.

Caution:

- Close the disc tray when not in use. Otherwise, dust may accumulate inside and cause malfunction.
- The unit gets slightly warm when used for a long time. It does not mean the unit is damaged.
- When attempting to play disc with scratches or of a different region number, or unplayable or restricted (*1) discs, an error message will appear on the TV display and the disc will not play.

(*1) Viewing is prohibited on some DVDs according to the audience age.

Notes:

- Stop positions may be recorded on some discs. When you play such a disc, playback stops there.
- During an operation, "This operation cannot be performed" may appear indicating that the operation is disabled by the disc.
- The main unit detects loaded discs automatically and then the indicators "DVD" light up on display for few second.



■ To resume playback after stopping (resume play) **DVD CD VCD DivX**

You can resume playback from the point playback is stopped.

1 Whilst a disc is playing, press the ■ (STOP) button.

The system stores the point you stopped.



2 To restart play, press the ▶ (PLAY) button.

Play resumes from the point you stopped.

To cancel the resume playback:

Press the **■** (STOP) button twice.

Notes:

- The resume playback feature is disabled on some discs.
- Depending on the disc, playback may resume from slightly before the stopped position.

■ DVD mode operation indicators **DVD**

The following are examples of operation indicators that appear during DVD playback.

Operation	TV screen	Unit display
When the power is on without a disc		NO DISC
Disc data is being read		LOADING
1st time Stop		RESUME
2nd time Stop		STOP
Play		22 79:57
Pause		22 80:04

Basic operation

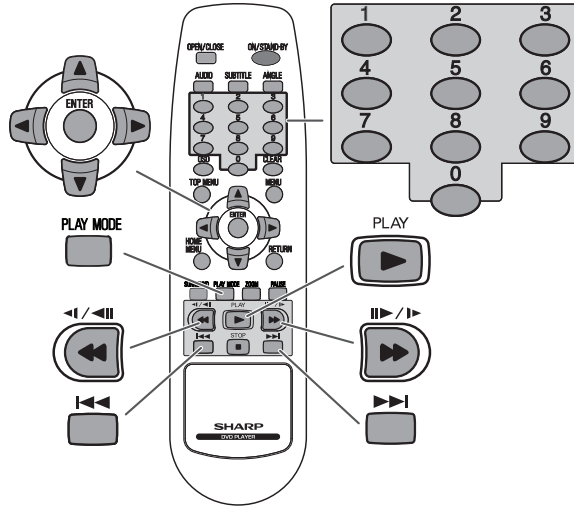

■ To locate the beginning of a chapter (track) (skip) DVD VCD CD DivX JPEG

You can move to other tracks with simple operations.
When playing VCD, cancel the P.B.C. (playback control) (see page 39).

Whilst a disc is playing, press the ◀◀ or ▶▶ button.

- Use the ▶▶ button to skip to the next chapter (track).
- Use the ◀◀ button twice to skip to the previous chapter (track).
- On DVD, VCD and Audio CD, press the ◀◀ button to skip to the beginning of the current chapter (track).

Notes:

- Some discs do not display the chapter (track) and the skip feature is disabled.
- Alternatively, press the ◀◀ or ▶▶ button on the main unit.

■ Fast forward/Fast backward (search)

DVD VCD CD DivX

You can search the desired point as you play the disc.

1 Whilst a disc is playing, press the ◀◀ or ▶▶ button.

Example: When the ▶▶ button is pressed;
On DVD/VCD/CD, the speed changes as follows:

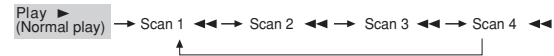

On DivX, the speed changes as follows:

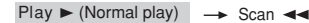
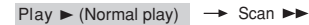

The disc is forwarded by the ▶▶ button and backward by the ◀◀ button.

2 Press the ▶ (PLAY) button to return to the normal playback.

Notes:

- On some discs, the search function is disabled.
- On a DVD, search does not operate between titles.
- On VCD and audio CD, the search can be operate between tracks.
- Whilst searching on a DVD, the sound is not heard.
- Whilst searching on a VCD, the sound is not heard.
- Audio CD disc sounds will break up during search. This is not a malfunction.
- When search is performed during the DVD playback, pictures may not be forwarded or reversed in the search speed specified in this manual, depending on the disc or the scene being played.
- The search does not operate on JPEG discs.

■ **To start playback from the desired point (direct play)** DVD VCD DivX

To select and play the desired title, chapter and time.

1 Whilst in the stop or playback mode, press the **PLAY MODE** button.

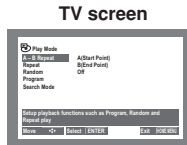

2 Select the “Search Mode” and press **ENTER** button.

3 Select the title, chapter or time search by pressing the cursor **▲** or **▼** button and then press **ENTER** button.

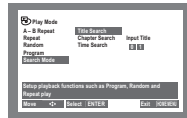

- The disc must be playing in the order to use the time search.

4 Use the direct number buttons to enter the title number, chapter number or time. Then press **ENTER** button to start playback.

Example:

To select chapter 12 : Press “1” and “2”.

To select title 3 : Press “3”.

To select time 1:23:45 : Press “8345”.

- Entering of time is base on minute basic.

5 To exit the “Play Mode” screen, press the **HOME MENU** button.

Notes:

- Direct play feature is disabled on some discs.
- Some discs may not display the chapter number.
- With DVDs, you can specify the desired point only in the current title and not in another title.
- Some discs cannot play from the specified point of the time.
- Time search feature is disabled on some discs.

■ **To start playback from the desired point by using disc navigator** DVD VCD

The contents of DVD, DVD-R/RW or VCD disc can be playback from the desired point by using Disc Navigator.

1 Whilst in the playback mode, press **HOME MENU** and select “Disc Navigator” from the on-screen menu. Then press **ENTER** button.



2 Disc Navigator menu will appear. The TV screen appears as shown below for DVD:



The TV screen appears as shown below for VCD:



- You cannot use the Disc Navigator with VCD in P.B.C. mode.

3 Select a view option by pressing the **ENTER** button. The options available depend on the kind of disc loaded and whether the disc is playing or not.

View options:

- Title – Titles from DVD disc.
- Chapter – Chapters from the current title of DVD disc.
- Track – Tracks from a VCD disc.
- Time – Thumbnails from VCD disc at 10 minutes intervals.

4 The TV screen shows up to six moving thumbnail images displayed one after another.



- To display the previous/next six thumbnails, press **◀** or **▶** button.

5 Select the thumbnail image for what you want to play by using the **▲**, **▼**, **◀** or **▶** button or direct number buttons and then press **ENTER** button.

Useful operation

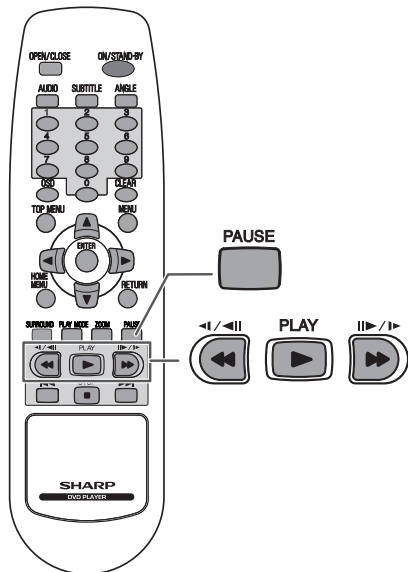

■ Still picture DVD VCD DivX

You can freeze the image during playback.

- 1 Whilst a disc is playing, press the **||** (PAUSE) button.
- 2 The image or picture will be freeze on TV screen.
“Pause II” appears briefly on the TV screen.
- 3 Press the **▶** (PLAY) button to return to the normal playback.

Note: The sound is muted during still picture.

■ Step function (Frame by frame playback) DVD VCD DivX

You can forward and backward the playback frame by frame.

- 1 Whilst a disc is playing, press the **||** (PAUSE) button, then follow by **||▶/▶** or **◀/◀||** button. Each press of the **||▶/▶** or **◀/◀||** button will forward or backward the frame.
- 2 Press the **▶** (PLAY) button to return to the normal playback.

Notes:

- Frame playback is operated forward only for VCD and DivX.
- Still picture and frame by frame playback features are disabled on some discs.
- The sound is muted during step function.

■ Slow-motion play DVD VCD DivX

You can slow down the playback speed, forward and backward.

- 1 Whilst a disc is playing, press the **||** (PAUSE) button, then follow by long press of **||▶/▶** or **◀/◀||** button. Follow by press the **||▶/▶** or **◀/◀||** button repeatedly, the speed changes as follows:

Slow-motion play forward:

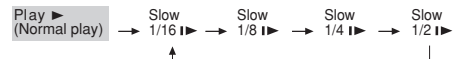

Slow-motion play backward:

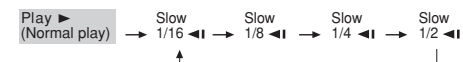

- 2 Press the **▶** (PLAY) button to return to the normal playback.

Notes:

- On some discs, the slow-motion play functions are disabled.
- Slow-motion playback is operated forward only for VCD and DivX.
- The sound is muted during slow-motion play function.

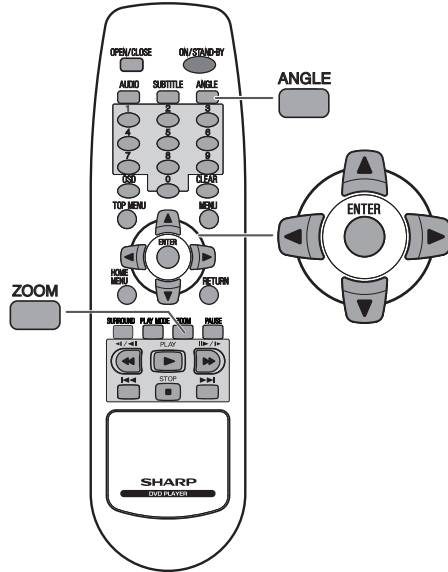

■ To change the angle DVD

You can change the angle of view when playing a DVD disc that contains scenes recorded from multiple angles.

When “” is displayed in the right corner of the TV screen, press the ANGLE button repeatedly to select the desired angle number.

Notes:

- The angle number is not displayed if angles are not recorded on the disc.
- Refer to the manual of the disc as the operation may vary depending on the disc.

■ To zoom images (zoom) DVD VCD JPEG DivX

You can magnify images zoom in during playback.

- 1 Whilst a disc is playing, press the ZOOM button. The navigation square at the top of the screen will appear as show:

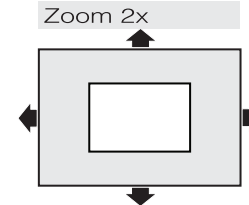

Each press of the ZOOM button cycles through the zoom setting as follows:

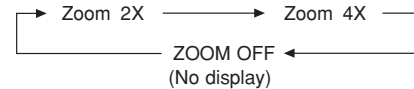

- 2 To shift the view and display the desired part of a zoomed image, press the ▲, ▼, ◀ or ▶ button repeatedly.

- If the navigation square at the top of the screen disappears, press ZOOM button again to display it.

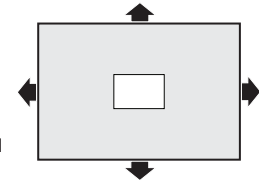

To return to normal view:

Press the ZOOM button repeatedly until "ZOOM OFF" (No display).

Notes:

- Images may become distorted when zoomed.
- Subtitles cannot be zoomed.
- For JPEG ZOOM function, please refer page 46 for details.

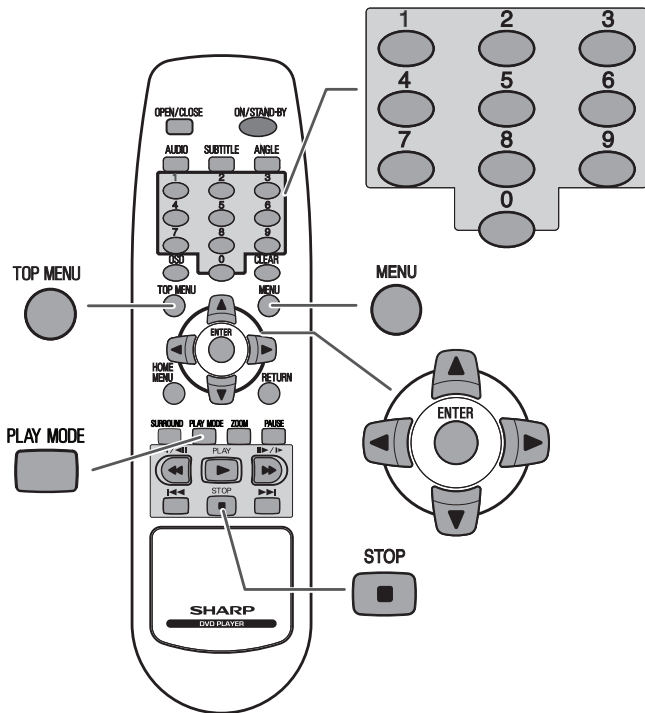

■ To play repeatedly (repeat play) DVD VCD CD DivX

You can play a chapter (track) or a title repeatedly by specifying it during playback. When playing VCD, cancel the P.B.C. (playback control) (see page 39).

1 Whilst a disc is playing, press the PLAY MODE button.

TV screen

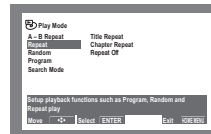

2 Select the "Repeat" and press the ENTER button.

3 Select the Title Repeat, Chapter Repeat or Repeat Off by pressing the cursor ▲ or ▼ button and then press the ENTER button.

4 To return to the normal playback, select Repeat Off and then press the ENTER button.

5 To exit the "Play Mode" screen, press the HOME MENU button.

Notes:

- Repeat play options available for DVD and DVD-RW discs are Title Repeat, Chapter Repeat or Repeat Off.
- For CD and VCD discs, you can select Disc Repeat, Track Repeat or Repeat off.
- For DivX discs, you can select Title Repeat and for some DivX media files, select Chapter Repeat or Repeat Off.

Caution:

After performing repeat play, be sure to select Repeat Off and then press the ENTER button. Otherwise, the disc will play continuously.

■ **To play the contents between the specified points repeatedly (A-B repeat)** DVD VCD CD

You can play the desired portion repeatedly by specifying it during playback.

1 Whilst a disc is playing, press the **PLAY MODE** button.



2 Select the “A-B Repeat” and press **ENTER** button. Then select the “A (Start Point)” and press **ENTER** button. This registers the start point (A).

3 Select the “B (End Point)” and press **ENTER** button to enter the end point (B). This starts A-B repeat from the start point (A) to the end point (B).



4 After completed the step 3, it will automatically exit the “Play Mode” screen.

5 To resume normal playback, select “Off” from the “Play Mode” menu and press **ENTER** button.

Notes:

- A-B repeat play is disabled on some discs.
- A-B repeat play for DVD is possible only within a title.
- A-B repeat play for VCD is possible only within a track.
- Some scenes on DVD may not allow A-B repeat play.
- A-B repeat play is disabled for VCD in P.B.C. mode.

■ **To select a title from the top menu of the disc** DVD

On a DVD with multiple titles, you can select a title from the top menu.

1 Whilst in the stop or playback mode, press the **TOP MENU** button to display its title menu.

2 Use the cursor **▲, ▼, ◀** or **▶** button to select the title you want.

3 Press the **ENTER** button to start playing the selected title.

Notes:

- Some DVDs use the term “top menu” instead of “title menu”.
- If the disc you are using does not have a title menu, nothing appears on the screen even if you press the **TOP MENU** button.
- The procedure shown here provides only general steps.
- The actual procedure for using the title menu depends on the disc you are using. See the disc jacket for details.

■ **To select a subtitle or audio language from the disc menu** DVD

You can select the desired subtitle or audio language and sound system [Dolby Digital (5.1ch) or DTS sound] on your DVD if it has a disc menu.

1 Whilst in the stop or playback mode, press the **MENU** button to display the disc menu.

2 Press the **▲, ▼, ◀** or **▶** button to change the setting and press the **ENTER** button.
Or use the direct number buttons for some discs.

Note:

The procedure shown here provides only general steps. The actual procedure for using the disc menu depends on the disc. See the disc jacket for details.

Various settings

The subtitle language, audio language and TV type you select during playback are reset each time you set this unit to the stand-by mode or switch the input. To keep your own settings, set them in the setup menu (see page 24).

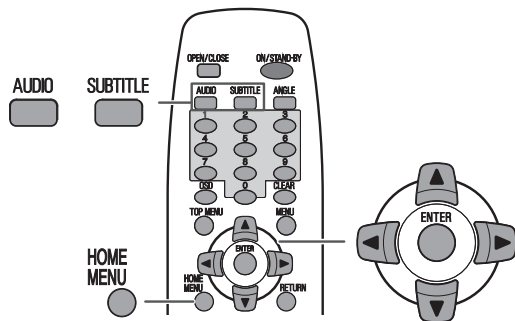

■ To change the subtitle language DVD

You can change the subtitle language or hide subtitles during playback.

Whilst a disc is playing, press the SUBTITLE button repeatedly to select the desired subtitle language.

Current/Total	English
Subtitle 5/12	

Notes:

- On some discs, the subtitle language cannot be changed.
- If no subtitles are recorded on the disc, “-/–” is displayed.
- It may take time to switch the subtitle language to the selected one.
- Subtitles cannot be hidden on some DVDs.

■ To change the audio language (audio output) DVD

During playback, you can change the audio language (audio output).

Whilst a disc is playing, press the AUDIO button repeatedly to select the desired audio number.

Current/Total	Dolby Digital 3/2.1CH
Audio 1/3	Japanese

You can select recorded languages.

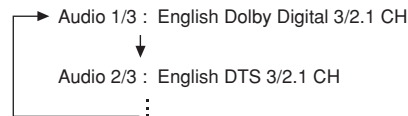

Notes:

- On some discs, the audio language cannot be changed.
- For the audio language and audio system, refer to the manual of the disc.

■ To change the HDMI resolution type and color (DV-SL2200W only) DVD VCD DivX

You can select the resolution type and colour.

- 1 Whilst in the stop mode, press the HOME MENU button. The HOME MENU screen will appear on the TV.



- 2 Select the "Initial Settings" by pressing the ▲, ▼, ◀ or ▶ button and press ENTER button. The "Initial Settings" screen will appear on the TV.

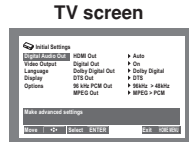

- 3 Select the "Video Output" by pressing the ▲, ▼, ◀ or ▶ button and press ENTER button. Then select "HDMI Resolution" or "HDMI Color" by pressing the ▲ or ▼ button and again press ENTER button.

TV screen for HDMI Resolution Option

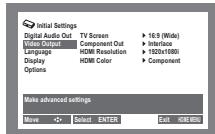

TV screen for HDMI Colour Option

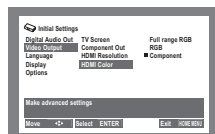

- 4 Select the HDMI Resolution or HDMI Color Option by pressing the ▲ or ▼ button and press ENTER button. At this stage you completed the HDMI resolution or HDMI color settings. To exit the "Initial Settings" screen, press the HOME MENU button.

Note:

The resolution type may not be changed whilst playback mode.

■ To change the display on TV screen

DVD VCD CD DivX

You can display or hide the operation indicators on the TV screen.

Whilst a disc is playing, press the OSD button. (The display is changed at each press.)

DVD:

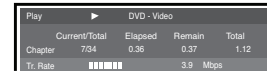
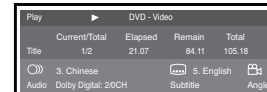

DivX:

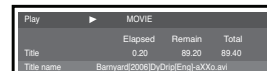

VCD (P.B.C. on):

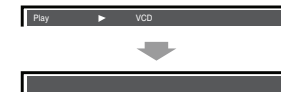

Audio CD/VCD (P.B.C. off):



Video CD operation

The following playback functions are the same as DVD or CD operations.

	Page
To locate the beginning of a chapter (track) (skip)	31
Fast forward/Fast backward (search)	31
To start playback from the desired point (direct play)	32
To start playback from the desired point by using disc navigator ...	32
Still picture	33
Step function (Frame by frame playback)	33
Slow-motion play	33
To zoom images (zoom)	34
To play repeatedly (repeat play)	35
To play the contents between the specified points repeatedly (A-B repeat)	36
To change the display on TV screen	38
Random play	40
To play in the desired order (programmed play)	41

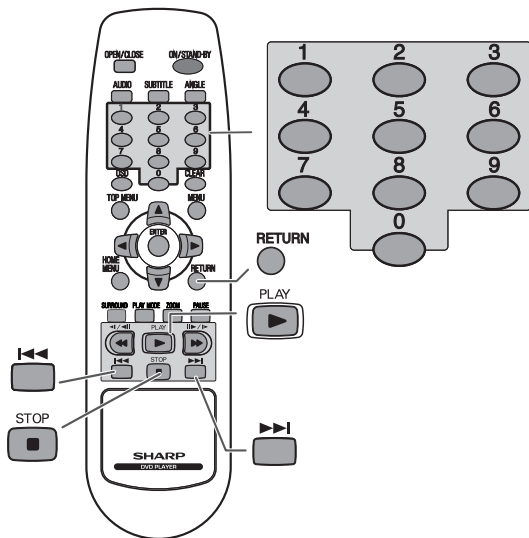

■ Playback of a video CD with P.B.C. ON VCD

P.B.C. mode will always on when you start playback Video CD disc.

- 1 The menu list will appear automatically for the VCD disc that have menu list and playback will be paused after you press the ► (PLAY) button.**

Example

 - For VCD disc that do not have menu list it will direct playback after you press ► (PLAY) button.
- 2 Select the desired menu number using the Direct Number buttons. Playback will starts.**

Notes:

- To turn off the P.B.C. mode, whilst in the stop mode, press Direct Number buttons then press ENTER button.
- To return back to the P.B.C. mode, whilst in the playback mode, press ■ (STOP) button twice then press ► (PLAY) button.
- To interrupt playback, press the || (PAUSE) button. To resume playback from the same point, press the ► (PLAY) button.
- To stop playback, press the ■ (STOP) button twice.
- To stop the current operation and return to the menu list, press the RETURN button.
- To scroll the menu list screen (menu list screen with more than 1 page), press the ◀◀ or ▶▶ button.
- The menu list screen cannot be scrolled on some discs.
- The P.B.C. function will not work in the following conditions:
Repeat/programmed/direct play /search mode or the skip feature is in operation.

■ Random play DVD VCD CD

The tracks on the disc(s) can be played in random order automatically.

- 1 Whilst in the stop mode or play mode, press the **PLAY MODE** button.

TV screen

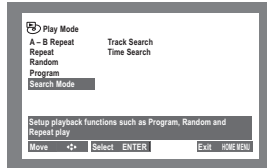

- 2 Select the “Random” and press **ENTER** button.

- 3 Depend on the kind of disc loaded, you can select the random play options.

TV screen for DVD discs

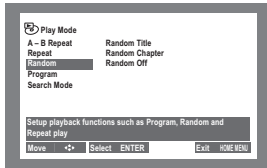

TV screen for VCD and CD discs

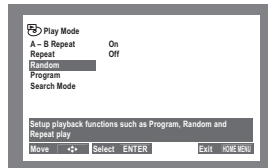

After select the random play option then, press **ENTER** button.

- 4 If unit in stop mode, press **▶ (PLAY)** button to play the random title, chapter or track. If unit in play mode, it would automatically continue play after completed the step 3.

- 5 To resume normal playback, select “Random Off” or “Off” from “Play Mode” menu and press **ENTER** button.

Notes:

- If you press the **▶▶▶** button during random play, you can select a new track/ title/chapter at random.
- In random play, the player will select and play tracks/title/chapter automatically. (You cannot select the order of the tracks.)
- During programme play or repeat play, random function will not work.
- Random function will not work during P.B.C. play. Cancel the P.B.C. mode before using this function on VCD disc with P.B.C.
- You cannot use random play with VR format DVD-R/RW discs, MP3/MPEG-4 AAC discs, DivX video disc or whilst a DVD disc menu is being displayed.

Caution:

After performing random play, be sure to perform step 5 or press the **■ (STOP)** button.

Otherwise, the disc(s) will play continuously.

■ To change the audio channel VCD

You can select an audio channel.

Whilst a disc is playing, press the **AUDIO button repeatedly to select the desired audio channel.**

The audio channel changes as follows on VCD:



Notes:

- The audio channel may not be changed on some discs.
- Audio button cannot function on audio CD.

CD operation

The following playback functions are the same as DVD or VCD operations.

Playback	Page 29
To resume playback after stopping (resume play)	30
To locate the beginning of a chapter (track) (skip)	31
Fast forward/Fast backward (search)	31
To play repeatedly (repeat play)	35
To play the contents between the specified points repeatedly (A-B repeat)	36
To change the display on TV screen	38
Random play	40

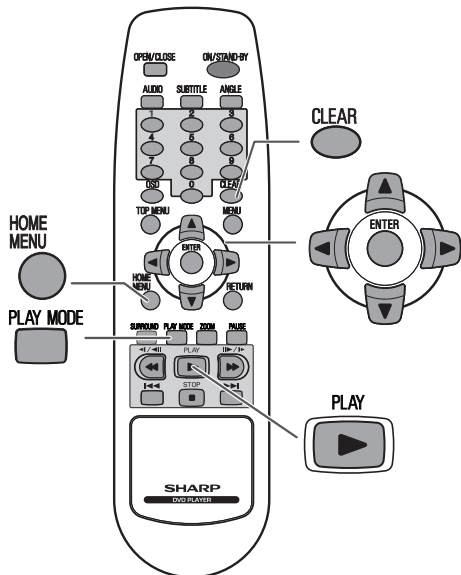

■ To play in the desired order (programmed play)

CD VCD DVD MP3

You can playback the desired titles/tracks/chapter in a specific order. Maximum of 24 titles/chapters/tracks can be programmed.

- 1 Whilst in the stop mode or play mode, press the **PLAY MODE** button. (You also can select "PLAY MODE" mode from HOME MENU display).

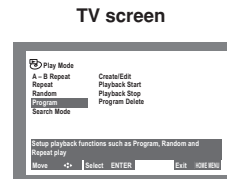

- 2 Select the "Program" and press **ENTER** button.

- 3 Select "Create/Edit" from the list of programme options and press **ENTER** button. Depend on the kind of disc loaded, below TV screen appears.

DVD:

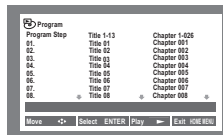

VCD/CD:

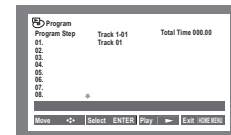

MP3:

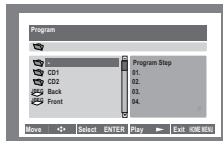

4 Use the cursor ▲, ▼, ◀ or ▶ button and ENTER button to select a title, chapter or track for the current step in the programme list.

- For DVD, you can add a title or a chapter to the programme list.
- For CD or VCD, select a track to add to the programme list.
- After press ENTER button to select the title/chapter/track, the step number automatically moves down one.

5 To build up a programme list, repeat step 4.

- To delete a programme step, highlight it by using the cursor ▲ or ▼ button and press CLEAR button.

6 To play the programme list, press ▶ (PLAY) button.

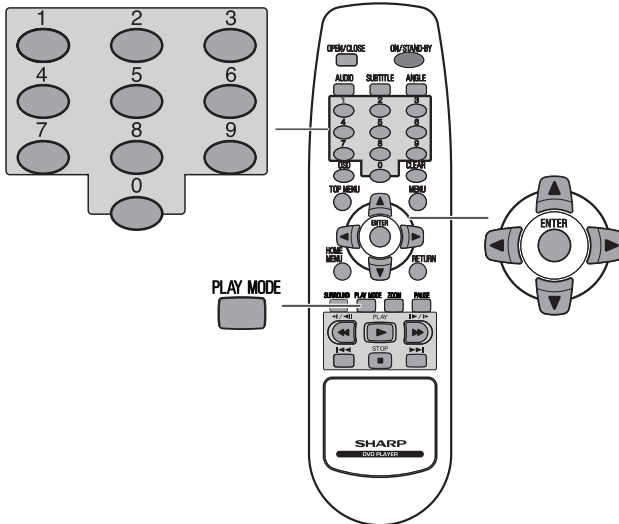

■ To start playback from the desired point (direct play) CD

To select and play the desired track and time.

1 Whilst in the playback mode, press the PLAY MODE button.

TV screen

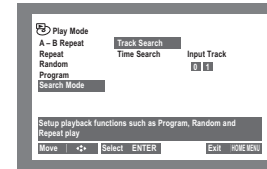

2 Select the “Search Mode” and press ENTER button.

3 Select the track or time search by pressing the cursor ▲ or ▼ button and then press ENTER button.

- The disc must be playing in order to use time search.

4 Use the direct number buttons to enter the track or time. Then press ENTER button to start playback.

Example:

To select track 12 : Press “1” and “2”.

To select time 1:23:45 : Press “8345”.

- Entering of time is base on minute basic.

Notes:

- Direct play feature is disabled on some discs.
- Some discs cannot play from the specified point of time.
- With CD, you can specify the desired time only in the current track and not in another track.
- Time search feature is disabled on some discs5.

CD operation (continued)

To change the programmed contents:

Repeat the above procedures from step 1.

Programmed contents will be cleared when you perform the following operations:

- Set to stand-by mode.
- Remove the disc.
- Switch off the player.
- Select the "Program Delete" option in the programme menu.
(At same time you turn off programme play)

Notes:

- You cannot use programme play with VR format DVD-R/RW discs, VCD playing in P.B.C. mode, JPEG or whilst a DVD disc menu is being played.
- During programmed play, repeat play can be performed by select the "Program Repeat" operation from "Play Mode" menu.
- On some discs, the programmed play function is disabled.
- You can starts playback of a saved programme list and turns off programme play but does not erase the programme list by select "Playback Start" and "Playback Stop" in the programme menu options list.

MP3/WMA folder mode (only for MP3/WMA files)

To play back MP3/WMA (Windows Media Audio) file

There are many music sites on the internet that you can download MP3/WMA (Windows Media Audio) music files. Follow the instructions from the website on how to download the music files. You can then play back these downloaded music files by burning them to a CD-R/RW disc or by connecting a USB Memory Player device.

- Your downloaded song/files are for personal use only. Any other usage of the song without owner's permission, is against the law.

■ About folder playback order

If MP3/WMA files are recorded in several folders, a folder number will be set to each folder automatically.

These folder can be selected by the ▲, ▼, ◀ or ▶ button on the remote control. If there is no supported file formats inside the selected folder, the folder is skipped and the next folder will be selected.

Example: How to set folder number if MP3/WMA format files are recorded as below figure.

1. ROOT folder is set as folder 1.
2. As for folders inside ROOT folder (Folder A and Folder B), the folder which is recorded earlier on the disc will be set as folder 2.
3. As for folder inside Folder A (Folder C and Folder D), the folder which is recorded earlier on the disc will be set as folder 3.
4. Because there is no folder in Folder C, Folder D will be set as folder 4.
5. Folder E that is inside Folder D will be set as folder 5.
6. Folder B inside ROOT folder will be set as folder 6.

* The folder and file order information which is recorded on the disc depends on the writing software. There may be possibilities that this unit will play back the files not according to our expected playback order.

All the files inside the selected folder will be played back.

In case Folder D is selected, file 6, 7 and 8 will be played back. File 9 and 10 in Folder E will not be played back.

DivX and JPEG disc operation

DV-SL1200W
DV-SL2200W

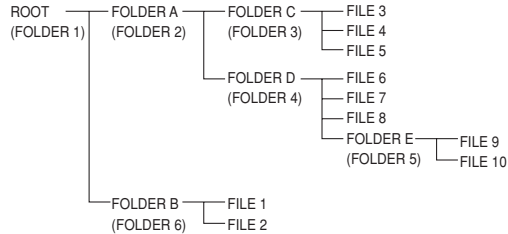

■ Procedure to playback MP3/WMA disc

To playback CD-R/CD-RW.

- 1 Load an MP3/WMA disc, then press MENU button, the menu screen appears.



- 2 Press the cursor ▲, ▼, ◀ or ▶ button to select a folder or a track and press the ENTER button.
 - Playback starts when you select a track.

Notes:

- WMA meta tag (ID3) are not supported on this unit.
- If "Cannot play this format" is displayed, it means "Copyright protected WMA file" or "Not supported playback file" is selected.
- After pressing the "PAUSE" button to pause the playback of MP3/WMA disc, press "PAUSE" button again to restarts a paused MP3/WMA disc.

The following playback functions are the same as DVD or VCD operations.

	Page
Playback	29
To locate the beginning of a chapter (track) (skip)	31
Fast forward/Fast backward (search)	31
Still picture	33
Step function (Frame by frame playback)	33
Slow-motion play	33
To zoom images (zoom)	34
To change the display on TV screen	38

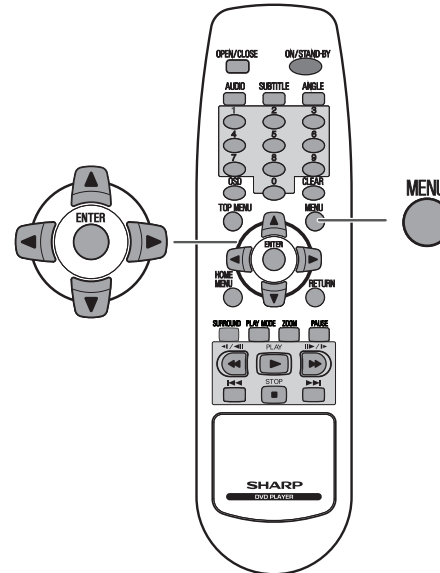

DivX and JPEG disc operation (continued)

■ Playback on the DivX and JPEG menu screen

JPEG DivX MP3

You can play CD-R/RW recorded in the DivX and JPEG formats.

1 Load a disc containing DivX and JPEG files, the menu screen appears.

- Below screen only appears for disc that have video format and audio format.



2 Press the cursor **▲** or **▼** button to select DivX format or MP3/WMA/JPEG formats and press ENTER button.

- Disc that have only one type of format no need to do above step.

3 Press the MENU button, the file menu screen appears.

- ... Indicates folders
- ... Indicates DivX data
- ... Indicates JPEG data

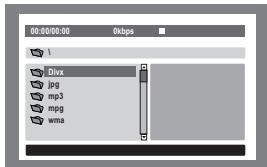

4 Press the cursor **▲**, **▼**, **◀** or **▶** button to select a folder or a track and press the ENTER.

- Playback starts when you select a track.
- When the format is JPEG, the next file is automatically displayed after a while.

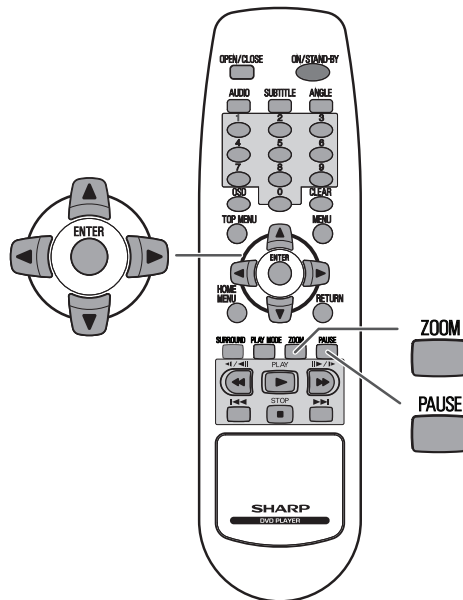

Note:

Due to the structure of the disc information, it takes longer time to read a JPEG or DivX disc than a normal CD.

Zoom function JPEG

1 During playback, press the ZOOM button.

Each press of the ZOOM button cycles through the zoom setting as follows:

1X → 2X → continue playback

2 To shift the view and display the desired part of a zoomed image, press the ▲, ▼, ◀ or ▶ button repeatedly.

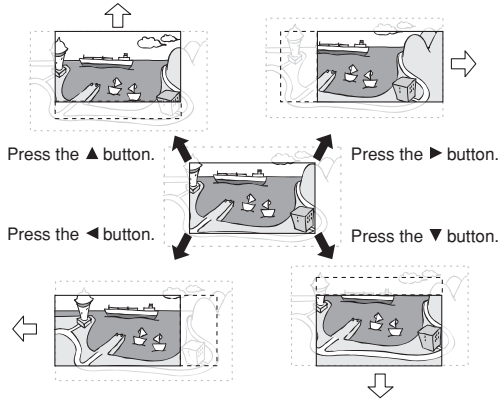

To return to normal view:

Press the ZOOM button again.

Rotating a picture JPEG

You can rotate images.

1) During playback, press the PAUSE button.

2) Press the ▲, ▼, ◀, ▶ button.

The image rotates as shown below.

▶ button : 90° rotation in a clockwise direction.

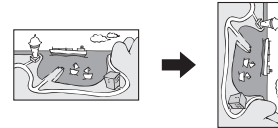

◀ button : 90° rotation in an anti-clockwise direction.

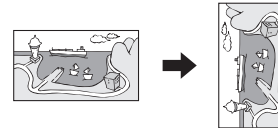

▲ button : Horizontal mirror image.

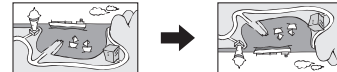

▼ button : Vertical mirror image.



Note:

If press the ◀ or ▶ button repeatedly, image rotates continuously.

USB memory device operation

■ Playback on USB memory device (DV-SL2200W only) JPEG MP3

You can play USB recorded in JPEG and MP3, WMA formats.

1 Press FUNCTION button to activate the USB mode.

2 Plug in the USB memory device and wait until TV screen appears.

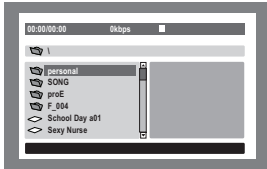

3 Press the ▲, ▼, ◀ or ▶ button to select a folder or a track and press the ENTER button.

- Playback starts when you select a track.
- When the format is JPEG, the next file is automatically displayed after a while.
- You can use the ▲, ▼, ◀ or ▶ button to rotate the JPEG picture (see page 46).

Note:

After pressing the "PAUSE" button to pause the playback of MP3/WMA format, press "PAUSE" button again to restarts a paused MP3/WMA format.

To remove USB memory device

1 Press the STOP ■ button on the remote control or ■ button on the unit.

2 Turn off the unit and disconnect the USB memory device from the terminal.

Notes:

- The unit will in USB mode on next start up.
To return to DVD mode, press FUNCTION button again.
- During USB mode, you have to press HOME MENU button twice to return to the HOME MENU display.

Notes:

- SHARP will not be held liable for the loss of data whilst the USB memory device is connected to the audio system.
- This USB memory's format support FAT 16 or FAT 32.
- SHARP cannot guarantee that all USB memory devices will work on this audio system.
- This USB memory cannot be operated via USB hub.
- If recorded file is not displayed in "ROOT" menu, it means that this format is not supported.
- The USB terminal in this unit is not intended for a PC connection but is used for music, video and image streaming with a USB memory device.
- The larger the capacity of the USB storage device, the longer it will take for the data to be read.
- Some USB multi-reader devices may not work correctly with the USB terminal on this unit.
- External storage devices cannot be played back using the USB terminal on this unit.
- This unit only supports "MPEG-1 Audio Layer-3" format.
(Sampling Frequency is 32, 44.1, 48kHz)
- "MPEG-2 Audio Layer-3", "MPEG-2.5 Audio Layer-3" and MP1, MP2 format are not supported.
- Playlists are not supported on this unit.
- The display playback time may not be displayed correctly when playing back a variable bitrate file.
- DRM (Digital Rights Management) or FairPlay copy-Protection file cannot be playback.

Troubleshooting chart

Many potential problems can be resolved by the owner without calling a service technician.

If something is wrong with this product, check the following before calling your authorised SHARP dealer or service centre.

■ General

Symptom	Possible cause
No sound is heard.	<ul style="list-style-type: none"> ● Are the speaker wires disconnected?
Noise is heard during playback.	<ul style="list-style-type: none"> ● Move the unit away from any computers or mobile phones.
Interference or noise occurs on the TV image.	<ul style="list-style-type: none"> ● Is the unit placed near TV with internal aerial? Use an external aerial.
The power is not turned on.	<ul style="list-style-type: none"> ● Is the unit unplugged? ● The protection circuit may be activated. Unplug and plug in the power lead again after 15 minutes or more.
No images are displayed.	<ul style="list-style-type: none"> ● Is TV turned on? ● Is the input of TV switched?

■ DVD player

Symptom	Possible cause
Even though a disc has been loaded, "NO DISC" is displayed. Playback sounds are skipped.	<ul style="list-style-type: none"> ● Is the disc loaded upside down? ● Is the disc very dirty? ● Does the disc satisfy the standards? ● Is the unit located near excessive vibrations? ● Has condensation formed inside the unit?
The control buttons do not function. Music or video playback is interrupted.	<ul style="list-style-type: none"> ● Is the disc very dirty? ● Does the disc satisfy the standards? ● Is the unit located near excessive vibrations? ● Has condensation formed inside the unit?
Pictures and sound are skipped.	<ul style="list-style-type: none"> ● Is the disc very dirty? ● Is the unit located near excessive vibrations? ● Has condensation formed inside the unit?
The unit does not operate even if the power is on.	<ul style="list-style-type: none"> ● Is a disc other than a DVD (region number on the back of the unit), VCD, audio CD, CD-R or CD-RW loaded?
Image cannot be played back. (Sound is not heard.)	<ul style="list-style-type: none"> ● Are the video and audio cables connected improperly? ● Is a disc other than a DVD (region number on the back of the unit), VCD, audio CD, CD-R or CD-RW loaded? ● Is the disc very dirty? ● Is the disc loaded upside down? ● Clean the optical pickup if it is dirty. ● Is the TV input set to "VIDEO 1/VIDEO 2", etc.? ● Is the unit turned on?

■ Remote control

Symptom	Possible cause
The remote control does not operate properly.	<ul style="list-style-type: none"> ● Is the battery polarity respected? ● Are the batteries dead? ● Is the distance or angle incorrect? ● Are there any obstructions in front of the unit? ● Is the remote control sensor exposed to strong light (inverter fluorescent light, direct sunlight, etc.)? ● Is the remote control for another equipment used simultaneously?

■ If problem occurs

When this product is subjected to strong external interference (mechanical shock, excessive static electricity, abnormal supply voltage due to lightning, etc.) or if it is operated incorrectly, it may malfunction.

If such a problem occurs, do the following:

- 1 Turn the unit power off and on again.
- 2 If the unit is not restored in the previous operation, unplug and plug in the unit, and then turn the power on.

■ Before transporting the unit

- 1 Press the ON/STAND-BY button to turn the power on.
- 2 Press the **▲** OPEN/CLOSE button to open the disc tray.
Remove the disc inserted in the unit.
- 3 Press the **▲** OPEN/CLOSE button to close the disc tray.
- 4 Press the ON/STAND-BY button to switch off, and then unplug the AC power lead from the wall socket.

■ Clearing all the memory (reset)

1. Press the ON/STAND-BY button to enter the power stand-by mode.
2. Using the front panel buttons only, press and hold the **■** button and then press ON/STAND-BY button until "CLEAR" appears in the unit display.

Notes:

- This operation will erase all data stored in the memory.
- All the player's settings are now reset to the factory default.

■ Condensation

Sudden temperature changes, storage or operation in an extremely humid environment may cause condensation inside the cabinet (laser pickup, etc.) or on the transmitter on the remote control.

Condensation can cause the unit to malfunction. If this happens, leave the power on with no disc in the unit until normal playback is possible (about 1 hour). Wipe off any condensation on the transmitter with a soft cloth before operating the unit.

Additional information

■ Language code list

Language (Language code letter), Language code

Japanese (ja), **1001**
 English (en), **0514**
 French (fr), **0618**
 German (de), **0405**
 Italian (it), **0920**
 Spanish (es), **0519**
 Chinese (zh), **2608**
 Dutch (nl), **1412**
 Portuguese (pt), **1620**
 Swedish (sv), **1922**
 Russian (ru), **1821**
 Korean (ko), **1115**
 Greek (el), **0512**
 Afar (aa), **0101**
 Abkhazian (ab), **0102**
 Afrikaans (af), **0106**
 Amharic (am), **0113**
 Arabic (ar), **0118**
 Assamese (as), **0119**
 Aymara (ay), **0125**
 Azerbaijani (az), **0126**
 Bashkir (ba), **0201**
 Byelorussian (be), **0205**
 Bulgarian (bg), **0207**
 Bihari (bh), **0208**
 Bislama (bi), **0209**
 Bengali (bn), **0214**
 Tibetan (bo), **0215**
 Breton (br), **0218**
 Catalan (ca), **0301**
 Corsican (co), **0315**
 Czech (cs), **0319**
 Welsh (cy), **0325**
 Danish (da), **0401**
 Bhutani (dz), **0426**
 Esperanto (eo), **0515**
 Estonian (et), **0520**
 Basque (eu), **0521**
 Persian (fa), **0601**
 Finnish (fi), **0609**
 Fiji (fj), **0610**
 Faroese (fo), **0615**
 Frisian (fy), **0625**
 Irish (ga), **0701**
 Scots-Gaelic (gd), **0704**
 Galician (gl), **0712**
 Guarani (gn), **0714**
 Gujarati (gu), **0721**
 Hausa (ha), **0801**
 Hindi (hi), **0809**
 Croatian (hr), **0818**
 Hungarian (hu), **0821**
 Armenian (hy), **0825**
 Interlingua (ia), **0901**
 Interlingue (ie), **0905**
 Inuplak (ik), **0911**
 Indonesian (in), **0914**
 Icelandic (is), **0919**
 Hebrew (iw), **0923**
 Yiddish (ji), **1009**
 Javanese (jw), **1023**
 Georgian (ka), **1101**
 Kazakh (kk), **1111**
 Greenlandic (kl), **1112**
 Cambodian (km), **1113**
 Kannada (kn), **1114**
 Kashmiri (ks), **1119**
 Kurdish (ku), **1121**
 Kirghiz (ky), **1125**
 Latin (la), **1201**
 Lingala (ln), **1214**
 Laothian (lo), **1215**
 Lithuanian (lt), **1220**
 Latvian (lv), **1222**
 Malagasy (mg), **1307**
 Maori (mi), **1309**
 Macedonian (mk), **1311**
 Malayalam (ml), **1312**
 Mongolian (mn), **1314**
 Moldavian (mo), **1315**
 Marathi (mr), **1318**
 Malay (ms), **1319**
 Maltese (mt), **1320**
 Burmese (my), **1325**
 Nauru (na), **1401**
 Nepali (ne), **1405**
 Norwegian (no), **1415**
 Occitan (oc), **1503**
 Oromo (om), **1513**
 Oriya (or), **1518**
 Panjabi (pa), **1601**
 Polish (pl), **1612**
 Pashto, Pushto (ps), **1619**
 Quechua (qu), **1721**
 Rhaeto-Romance (rm), **1813**
 Kirundi (rn), **1814**
 Romanian (ro), **1815**
 Kinyarwanda (rw), **1823**
 Sanskrit (sa), **1901**
 Sindhi (sd), **1904**
 Sangho (sg), **1907**
 Serbo-Croatian (sh), **1908**
 Sinhalese (si), **1909**

Slovak (sk), **1911**
 Slovenian (sl), **1912**
 Samoan (sm), **1913**
 Shona (sn), **1914**
 Somali (so), **1915**
 Albanian (sq), **1917**
 Serbian (sr), **1918**
 Siswati (ss), **1919**
 Sesotho (st), **1920**
 Sundanese (su), **1921**
 Swahili (sw), **1923**
 Tamil (ta), **2001**
 Telugu (te), **2005**
 Tajik (tg), **2007**
 Thai (th), **2008**
 Tigrinya (ti), **2009**
 Turkmen (tk), **2011**
 Tagalog (tl), **2012**
 Setswana (tn), **2014**
 Tonga (to), **2015**
 Turkish (tr), **2018**
 Tsonga (ts), **2019**

Tatar (tt), **2020**
 Twi (tw), **2023**
 Ukrainian (uk), **2111**
 Urdu (ur), **2118**
 Uzbek (uz), **2126**
 Vietnamese (vi), **2209**
 Volapük (vo), **2215**
 Wolof (wo), **2315**
 Xhosa (xh), **2408**
 Yoruba (yo), **2515**
 Zulu (zu), **2621**

■ Country/Area code list

Country/Area, Country/Area code, Country/Area code letter

Argentina, **0118, ar**
 Australia, **0121, au**
 Austria, **0120, at**
 Belgium, **0205, be**
 Brazil, **0218, br**
 Canada, **0301, ca**
 Chile, **0312, cl**
 China, **0314, cn**
 Denmark, **0411, dk**
 Finland, **0609, fi**
 France, **0618, fr**
 Germany, **0405, de**
 Hong Kong, **0811, hk**
 India, **0914, in**
 Indonesia, **0904, id**
 Italy, **0920, it**
 Japan, **1016, jp**
 Korea, Republic of, **1118, kr**
 Malaysia, **1325, my**
 Mexico, **1324, mx**
 Netherlands, **1412, nl**
 New Zealand, **1426, nz**
 Norway, **1415, no**
 Pakistan, **1611, pk**
 Philippines, **1608, ph**
 Portugal, **1620, pt**
 Russian Federation, **1821, ru**
 Singapore, **1907, sg**
 Spain, **0519, es**
 Sweden, **1905, se**
 Switzerland, **0308, ch**
 Taiwan, **2023, tw**
 Thailand, **2008, th**
 United Kingdom, **0702, gb**
 USA, **2119, us**

Note:

Above list only lists up main countries code.

Error indicators and warnings

When you load an unplayable disc or fail to perform operations properly, the following messages are displayed on the unit and the TV screen.

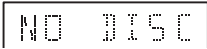
Unit display	Meaning
	<ul style="list-style-type: none"> ● The disc is not loaded. ● The disc is scratched or dirty and cannot be recognised. ● The disc is loaded up-side down.

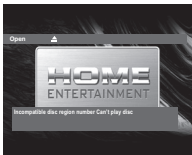
TV screen	Meaning
	<ul style="list-style-type: none"> ● The region number of the DVD is not the number on the back of the unit.

Maintenance

■ Cleaning the cabinet

Periodically wipe the cabinet with a soft cloth and a diluted soap solution, then with a dry cloth.

- Do not use chemicals for cleaning (petrol, paint thinner, etc.). It may damage the cabinet finish.
- Do not apply oil to the inside of the unit. It may cause malfunctions.

Specifications

As part of our policy of continuous improvement, SHARP reserves the right to make design and specification changes for product improvement without prior notice. The performance specification figures indicated are nominal values of production units. There may be some deviations from these values in individual units.

■ General

Power source	AC 110 - 240 V ~ 50/60 Hz
Power consumption	Power on: 7 W (DV-SL1200W) 11 W (DV-SL2200W)
Dimensions	Width: 420 mm (16 - 1/2") Height: 49.5 mm (1 - 61/64") Depth: 216 mm (8 - 33/64")
Weight	1.68 kg (3.70 lbs) DV-SL1200W 1.71 kg (3.77 lbs) DV-SL2200W
Audio output terminals	Analogue output (OUT): RCA type x 1 pair (L/R)
Video output terminals	Component (Y, P _B , P _R) Video output: RCA type x 1
Digital output terminal	COAXIAL
HDMI output terminal	HDMI socket for DV-SL2200W only.

■ DVD player

Signal system	PAL 625/50, NTSC 525/60	
Supported disc types	DVD (with the same region number on the back of the unit), VCD, audio CD, CD-R, CD-RW, JPEG, DivX.	
Video signal	Horizontal resolution: 500 lines S/N ratio: 65 dB	
Audio signal	Frequency characteristics	Linear PCM DVD: 4 Hz to 44 kHz (+/- 1.0 dB)
	S/N ratio	DVD: 90 dB (1kHz)
	Dynamic range	Linear PCM DVD: 88 dB
	Total harmonic distortion ratio	0.01% maximum

■ USB (DV-SL2200W only)

Class	Mass storage class
Support file	MP3/WMA (do not support DRM file)
Format support	FAT 16 or FAT 32
Bitrate support	MP3 (32 ~ 320 kbps) WMA (64 ~ 160 kbps)
Other	USB supports version 2.0

MEMO

MEMO

SHARP

SHARP CORPORATION



J2L32101A SH 08/07 

08F R KI ①